

# Panasonic<sup>®</sup>

## Operating Instructions

---

5.8 GHz Expandable Digital Cordless Answering System

Model No. **KX-TG5571**  
**KX-TG5576**

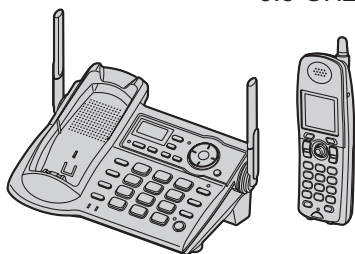

This unit is compatible with Caller ID. To use this feature, you must subscribe to the appropriate service offered by your service provider.

**Charge the battery for 6 hours before initial use.**

Please read these Operating Instructions before using the unit and save for future reference.

For assistance, visit our website: <http://www.panasonic.com> for customers in the U.S.A. or Puerto Rico.

## Table of Contents

### Introduction

About these operating instructions . . . . .	4
Accessory information . . . . .	5
Expanding your phone . . . . .	6
Available accessory handsets . . . . .	7
Important safety instructions . . . . .	8
For best performance . . . . .	10

### Preparation

Connections . . . . .	11
Battery installation . . . . .	12
Battery charge . . . . .	13
Battery replacement . . . . .	14
Screen saver mode (Color display models only) . . . . .	14
Controls and displays . . . . .	15
Controls . . . . .	15
Displays . . . . .	17
Setting the unit before use . . . . .	19
Setting the dialing mode . . . . .	19
Setting the date and time  . . . . .	19

### Making/Answering Calls

Making calls using the handset . . . . .	20
Useful features during a call . . . . .	21
Making calls using the base unit . . . . .	23
Useful features during a call . . . . .	24
Answering calls using the handset . . . . .	25
Answering calls using the base unit . . . . .	26
Adjusting the ringer volume . . . . .	26
Changing the ringer tone . . . . .	26

### Phonebook

Handset phonebook . . . . .	27
Adding items to the phonebook . . . . .	27
Calling someone in the phonebook . . . . .	28
Adding items/calling someone in the phonebook using the unit's menu  (Monochrome display models only) . . . . .	28
Editing items in the phonebook . . . . .	29
Erasing items in the phonebook . . . . .	29
Chain dial feature . . . . .	29
Copying phonebook items . . . . .	30

### Speed Dialer

Base unit speed dialer . . . . .	31
Adding phone numbers to the speed dialer . . . . .	31

Calling someone with the speed dialer . . . . .	31
---	----



### Caller ID Service

Using Caller ID service . . . . .	32
Talking Caller ID . . . . .	32
Ringer ID and light-up ID . . . . .	33
Picture ID (Color display models only) . . . . .	34
Caller list . . . . .	35
Viewing the caller list and calling back . . . . .	35
Editing a caller's phone number before calling back . . . . .	35
Storing caller information into the phonebook . . . . .	36
Erasing caller information . . . . .	36

### Intercom Features

Intercom . . . . .	37
Voice paging . . . . .	38
Transferring a call . . . . .	38
Transferring a call from the handset . . . . .	38
Transferring a call from the base unit . . . . .	39
Transferring a call to the answering system . . . . .	39
Conference calls . . . . .	40
Using the handset . . . . .	40
Using the base unit . . . . .	40
Room monitor . . . . .	41
Setting room monitor . . . . .	41
Monitoring a room . . . . .	41

### Programmable Settings

Guide to handset programming . . . . .	43
Programming via direct commands . . . . .	46
Direct commands chart . . . . .	46
Ringer settings  . . . . .	49
Handset ringer volume . . . . .	49
Handset ringer tone . . . . .	49
Recording songs from an audio device for ringer tones (Customize ring) . . . . .	50
Ring color . . . . .	51
Function  . . . . .	52
Voice enhancer . . . . .	52
Memory status (Color display models only) . . . . .	52

Customer support . . . . . 53

Display setting  (Color display models only) . . . . . 54

    Wallpaper . . . . . 54

    Handset display color (Appearance) . . . . . 55

    Handset LCD contrast . . . . . 55

Initial setting  . . . . . 55

    Handset Talking Caller ID . . . . . 55

    Caller ID edit . . . . . 55

    Handset LCD contrast (Monochrome display models only) . . . . . 56

    Handset key tone . . . . . 56

    Auto talk . . . . . 56

    Handset interrupt tone . . . . . 56

    Handset display language . . . . . 56

    Flash time . . . . . 57

    Line mode . . . . . 57

    Base unit settings . . . . . 57

    Canceling the handset registration . . . . . 58

    Registering the handset . . . . . 59

Set date & time  . . . . . 59

    Time adjustment (Caller ID subscribers only) . . . . . 59

**Answering System Features**

Answering system . . . . . 60

Recording your greeting message . . . . . 60

    Erasing your greeting message . . . . . 61

    Pre-recorded greeting message . . . . . 61

Turning the answering system on/off . . . . . 61

    Screening your calls . . . . . 61

Listening to messages . . . . . 62

    Listening to messages using the base unit . . . . . 62

    Listening to messages using the handset . . . . . 63

Recording a voice memo . . . . . 64

Memory capacity . . . . . 65

Remote operation . . . . . 65

    Using the answering system remotely . . . . . 65

Answering system settings  . . . . . 67

    Remote code . . . . . 67

    Ring count . . . . . 68

    Caller's recording time . . . . . 69

    Message alert . . . . . 69

    Turning call screening on/off . . . . . 69

**Useful Information**

Wall mounting . . . . . 70

Belt clip . . . . . 73

Headset (optional) . . . . . 73

Error messages . . . . . 74

Troubleshooting . . . . . 76

FCC and other information . . . . . 83

openLCR service for the Caller IQ feature . . . . . 85

Specifications . . . . . 86

Warranty . . . . . 87

Customer services . . . . . 89

**Index**

Index . . . . . 90

## Introduction

---

### Thank you for purchasing a Panasonic cordless telephone.

We recommend keeping a record of the following information for future reference.

Serial No. (found on the bottom of the unit)	Date of purchase
Name and address of dealer	

---

Attach your purchase receipt here.

#### Energy Star:

As an ENERGY STAR® Participant, Panasonic has determined that this product meets the ENERGY STAR guidelines for energy efficiency. ENERGY STAR is a U.S. registered mark.



#### Trademarks:

openLCR, openLCR.com, and the openLCR logo are the trademarks of openLCR.com, Inc.

---

## About these operating instructions

These operating instructions can be used for both the KX-TG5571 and the KX-TG5576.

#### Notable differences between the KX-TG5571 and KX-TG5576:

The KX-TG5571 features a monochrome display handset.

The KX-TG5576 features a color display handset with USB-support.

#### Important:

- Features and operations indicated by “**monochrome display models**” are for KX-TG5571 users and KX-TGA550 (accessory handset) users only.
- Features and operations indicated by “**color display models**” are for KX-TG5576 users and KX-TGA551 or KX-TGA552 (accessory handset) users only.
- See page 7 for the differences between the accessory handsets available for the KX-TG5571 and KX-TG5576.
- References in these operating instructions to a charger or other handsets are for accessory handset users only. See “Expanding your phone” on page 6.
- For information on connecting the KX-TG5576 and KX-TGA552 to a PC, refer to the included “Installation Guide for GIGARANGE USB Utility”.

## Accessory information

### Included accessories

- To order replacement accessories, call 1-800-332-5368.  
TTY users (hearing or speech impaired users) can call 1-866-605-1277.

No.	Accessory items	Order number	Quantity	
			KX-TG5571	KX-TG5576
①	AC adaptor for base unit	PQLV1Z	1	1
②	Telephone line cord	PQJA10075Z	1	1
③	Wall mounting adaptor	PQKL10068Z1	1	1
④	Battery	HHR-P104	1	1
⑤	Handset cover	PQYNTG5432MR	1	1
⑥	Belt clip	PQKE10396Z2	1	1
⑦	Audio cable	PQJA10165Z	1	1
⑧	USB cable	PQJA10166Z	–	1
⑨	CD-ROM*1	PQJKTG5576Z	–	1

①

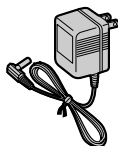

②



③

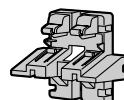

④

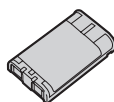

⑤



⑥



⑦



⑧

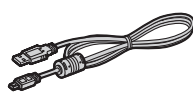

⑨

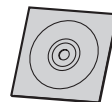

\*1 Allows you to install the GIGARANGE USB Utility software on a compatible PC. This software allows you to send pictures and songs from your PC to the handset, as well as create and edit phonebook items using your PC. Refer to the included "Installation Guide for GIGARANGE USB Utility" for installation details.

## Introduction

### Additional/replacement accessories

- To order replacement accessories, call 1-800-332-5368.  
TTY users (hearing or speech impaired users) can call 1-866-605-1277.

Accessory items	Order number
Rechargeable nickel metal hydride (Ni-MH) battery	HHR-P104
Accessory handset with charger	KX-TGA550 (features a 1.6 inch monochrome display) KX-TGA551 (features a 1.4 inch color display) KX-TGA552 (features a 1.6 inch color display)
Charger	PQLV30030ZM
AC adaptor for charger	KX-TCA1-G
Headset	KX-TCA60, KX-TCA86, KX-TCA88, KX-TCA88HA, KX-TCA91, KX-TCA92, or KX-TCA98
Battery back-up power supply	KX-TCA200

## Expanding your phone

The KX-TG5571 and KX-TG5576 each include one handset and one base unit. You can expand the system by adding up to 7 accessory handsets, sold separately. A maximum of 8 handsets can be registered to a base unit.

Any combination of the 3 available accessory handsets is possible.

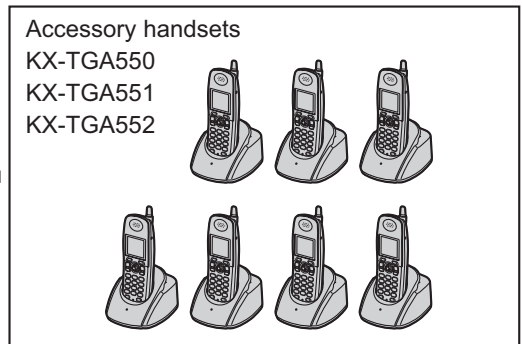

### Note:

- The included handset is pre-registered at the factory and assigned the extension number 1.
- In most situations 4 units can be operated at once, however, the number of units that can be operated at once may be lower depending on the features being used.

## Available accessory handsets

3 accessory handset models are available for the KX-TG5571 and KX-TG5576. Operations and features of 3 different accessory handsets have certain differences as indicated in the table below.

Feature	KX-TGA550	KX-TGA551	KX-TGA552	Page
Description	Same handset supplied with KX-TG5571	Available as accessory handset only	Same handset supplied with KX-TG5576	–
Display type	Monochrome	Color	Color	–
Display size	1.6 inch	1.4 inch	1.6 inch	–
Control type	Joystick	Navigator key	Joystick	16
USB-support <sup>*1</sup>	–	–	●	*2
Picture ID	–	–	●	34
Picture download feature	–	–	●	*2
Song record feature	●	●	●	50
Song download feature	–	–	●	*2
Wallpaper	–	●	●	54
Wallpaper download feature	–	–	●	*2
Memory status display	–	–	●	52

\*1 USB-support allows you to connect the handset to your PC and send pictures and songs from your PC to the handset, as well as create and edit phonebook entries using your PC.

\*2 For information on using this feature, refer to the help section of the GIGARANGE USB Utility software. If you have not installed the GIGARANGE USB Utility software, refer to the included "Installation Guide for GIGARANGE USB Utility" for details.

For information on ordering accessory handsets, see page 6.

### Important safety instructions

When using this unit, basic safety precautions should always be followed to reduce the risk of fire, electric shock, or personal injury.

1. Read and understand all instructions.
2. Follow all warnings and instructions marked on this unit.
3. Unplug this unit from power outlets before cleaning. Do not use liquid or aerosol cleaners. Use a damp cloth for cleaning.
4. Do not use this unit near water, for example near a bathtub, wash bowl, kitchen sink, etc.
5. Place the unit securely on a stable surface. Serious damage and/or injury may result if the unit falls.
6. Do not cover slots and openings on the unit. They are provided for ventilation and protection against overheating. Never place the unit near radiators, or in a place where proper ventilation is not provided.
7. Use only the power source marked on the unit. If you are not sure of the type of power supplied to your home, consult your dealer or local power company.
8. Do not place objects on the power cord. Install the unit where no one can step or trip on the cord.
9. Do not overload power outlets and extension cords. This can result in the risk of fire or electric shock.
10. Never push any objects through slots in this unit. This may result in the risk of fire or electric shock. Never spill any liquid on the unit.
11. To reduce the risk of electric shock, do not disassemble this unit. Take the unit to an authorized service center when service is required. Opening or removing covers may expose you to dangerous voltages or other risks.

Incorrect reassembly can cause electric shock when the unit is subsequently used.

12. Unplug this unit from power outlets and refer servicing to an authorized service center when the following conditions occur:
  - A. When the power cord is damaged or frayed.
  - B. If liquid has been spilled into the unit.
  - C. If the unit has been exposed to rain or water.
  - D. If the unit does not work normally by following the operating instructions. Adjust only controls covered by the operating instructions. Improper adjustment may require extensive work by an authorized service center.
  - E. If the unit has been dropped or physically damaged.
  - F. If the unit exhibits a distinct change in performance.
13. During thunderstorms, avoid using telephones except cordless types. There may be a remote risk of an electric shock from lightning.
14. Do not use this unit to report a gas leak, when in the vicinity of the leak.

## SAVE THESE INSTRUCTIONS

### CAUTION:

#### Installation

- Never install telephone wiring during a lightning storm.
- Never install telephone jacks in wet locations unless the jack is specifically designed for wet locations.
- Never touch uninsulated telephone wires or terminals unless the telephone line has been disconnected at the network interface.
- Use caution when installing or modifying telephone lines.



- Do not touch the plug with wet hands.
- The AC adaptor is used as the main disconnect device. Ensure that the AC outlet is installed near the unit and is easily accessible.
- To prevent the electric shock, use only the included audio cable with the transformer when connecting the unit to an audio device.

### Battery

To reduce the risk of fire or injury to persons, read and follow these instructions.

- Use only the battery(ies) specified.
- Do not dispose of the battery(ies) in a fire. They may explode. Check with local waste management codes for special disposal instructions.
- Do not open or mutilate the battery(ies). Released electrolyte is corrosive and may cause burns or injury to the eyes or skin. The electrolyte may be toxic if swallowed.
- Exercise care when handling the battery(ies). Do not allow conductive materials such as rings, bracelets or keys to touch the battery(ies), otherwise a short circuit may cause the battery(ies) and/or the conductive material to overheat and cause burns.
- Charge the battery(ies) provided with or identified for use with this product only in accordance with the instructions and limitations specified in this manual.

### WARNING:

- To prevent the risk of fire or electrical shock, do not expose this product to rain or any type of moisture.
- Unplug this unit from power outlets if it emits smoke, an abnormal smell or makes an unusual noise. These conditions can cause fire or electric shock. Confirm that smoke has stopped and contact the Panasonic Call Center at 1-800-211-PANA (7262).

### Medical

- Consult the manufacturer of any personal medical devices, such as pacemakers or hearing aids, to determine if they are adequately shielded from external RF (radio frequency) energy. (The unit operates in the frequency range of 5.76 GHz to 5.84 GHz, and the power output level can range from 0.25 to 0.5 watts.) Do not use the unit in health care facilities if any regulations posted in the area instruct you not to do so. Hospitals or health care facilities may be using equipment that could be sensitive to external RF (radio frequency) energy.

### For best performance

#### Base unit location/noise

The base unit and handset use radio waves to communicate with each other. For maximum distance and noise-free operation, we recommend the following:

- Placing the unit away from electrical appliances such as a TV, personal computer or another cordless phone.
- Placing the base unit in a HIGH and CENTRAL location with no obstructions such as walls.
- Raising the antennas vertically.
- If you use the handset near a microwave oven which is being used, noise may be heard. Move away from the microwave oven and closer to the base unit.
- If you use the handset near another cordless phone's base unit, noise may be heard. Move away from the other cordless phone's base unit and closer to your base unit.

#### Environment

- Keep the unit away from electrical noise generating devices, such as fluorescent lamps and motors.
- The unit should be kept free from excessive smoke, dust, high temperature and vibration.
- The unit should not be exposed to direct sunlight.
- Do not place heavy objects on top of the unit.
- When you leave the unit unused for a long period of time, unplug this unit from power outlet.
- The unit should be kept away from heat sources such as heaters, kitchen stoves, etc. It should not be placed in rooms where the temperature is less than 5 °C (41 °F) or greater than 40 °C (104 °F). Damp basements should also be avoided.

- The maximum calling distance may be shortened when the unit is used in the following places: Near obstacles such as hills, tunnels, undergrounds, near metal objects such as wire fences, etc.
- Operating near 5.8 GHz electrical appliances may cause interference. Move away from the electrical appliances.

#### Routine care

- Wipe the outer surface of the unit with a soft cloth. Do not use benzine, thinner or any abrasive powder.

## Connections

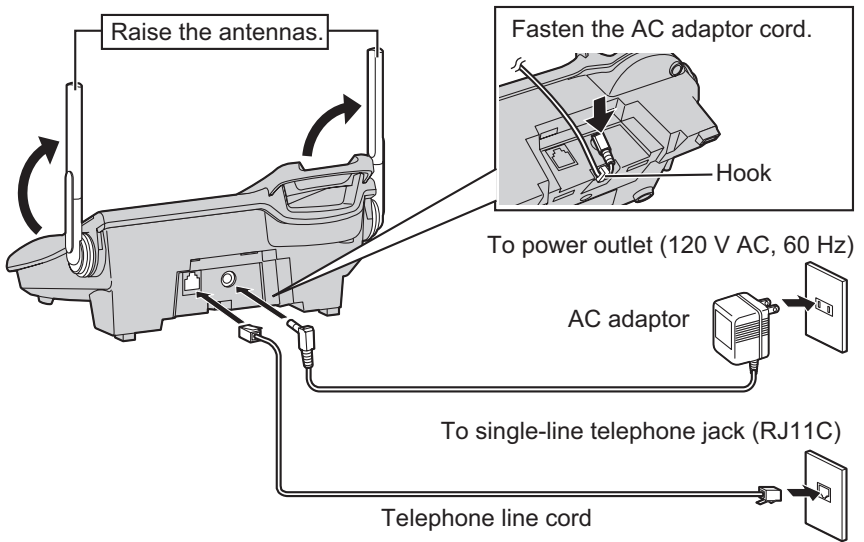

### Note:

- Use only the included Panasonic AC adaptor PQLV1.
- The AC adaptor must remain connected at all times. (It is normal for the adaptor to feel warm during use.)
- The AC adaptor should be connected to a vertically oriented or floor-mounted AC outlet. Do not connect the AC adaptor to a ceiling-mounted AC outlet, as the weight of the adaptor may cause it to become disconnected.
- The unit will not work during a power failure. We recommend connecting a standard telephone to the same telephone line or to the same telephone jack using the Panasonic KX-J66 T-adaptor. Emergency power can be supplied to the unit by connecting a Panasonic battery back-up power supply noted on page 6.

## Preparation

### If you subscribe to a DSL service

- Please attach a noise filter (contact your DSL provider) to the telephone line between the base unit and the telephone line jack in the event of the following:
  - Noise is heard during conversations.
  - Caller ID features (page 32) do not function properly.

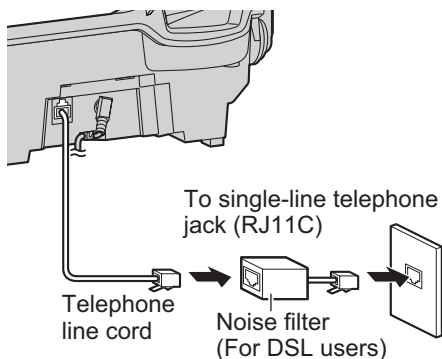

## Battery installation

- 1 Insert the battery (①), and press it down until it snaps into the compartment (②).

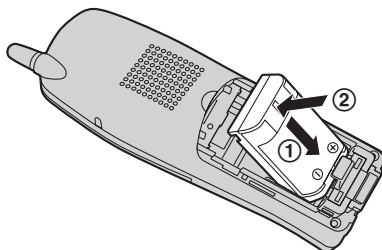

- 2 Close the handset cover.

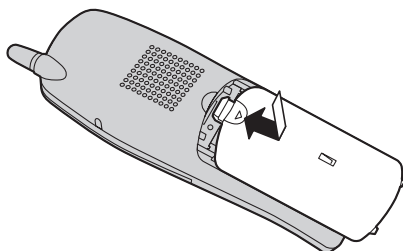

## Battery charge

Place the handset on the base unit for **6 hours** before initial use.

- The unit will beep once, the CHARGE indicator will light, and “Charging” will be displayed.
- “Charge completed” is displayed when the battery has been fully charged. The CHARGE indicator will remain lit.

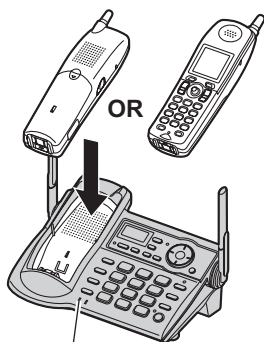

CHARGE indicator

### Note:

- To ensure the battery charges properly, clean the charge contacts of the handset and base unit with a soft, dry cloth once a month. Clean more often if the unit is subject to grease, dust, or high humidity.

## Battery strength

You can confirm the battery strength on the handset display.

Battery icon	Battery strength
	Fully charged
	Medium
	Low When flashing: needs to be recharged.
	Discharged

## Recharging the battery

Recharge the battery when:

- “Recharge battery” is displayed or flashes on the handset display.
- the handset beeps intermittently while it is in use.

### Note:

- Recharge the handset battery for more than 15 minutes, or the display will continue showing the indication.
- If the battery has been discharged, the handset will display “Charge for 6 HRS” and when you place the handset on the base unit.

## Battery performance

After your Panasonic battery is fully charged, you can expect the following performance:

Operation	Operating time
While in use (talking)	Up to 5 hours
While not in use (standby)*1	Up to 11 days
While using the clarity booster feature (page 22)	Up to 3 hours

\*1 Handset is off the base unit but not in use.

### Note:

- Battery power is consumed whenever the handset is off the base unit, even when the handset is not in use. The longer you leave the handset off the base unit, the shorter you can actually talk on the handset. Actual battery performance depends on a combination of how often the handset is in use and how often it is not in use.
- Once the battery is fully charged, you do not have to charge it again until “Recharge battery” is displayed or flashes. This will maximize the battery life.

### Battery replacement

If battery performance diminishes, make sure you have cleaned the charge contacts and fully charged the battery. The battery needs to be replaced if any of the following are displayed after a few phone calls even when you have fully charged the battery.

– “Recharge battery”

–  (flashing)

– “Charge for 6 HRS”

– 

- Use only the rechargeable Panasonic battery noted on page 6.

- 1 Press the notch on the cover firmly and slide it as indicated by the arrow.

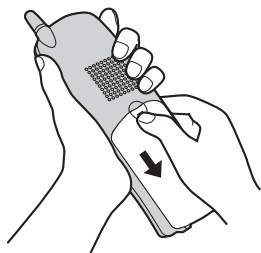

- 2 Replace the old battery with a new one, and close the cover (see page 12 for battery installation).

#### Attention:



A nickel metal hydride battery that is recyclable powers the product you have purchased. Please call 1-800-8-BATTERY for information on how to recycle this battery.

### Screen saver mode (Color display models only)

#### Important:

- Only the KX-TG5576, KX-TGA551, and KX-TGA552 support this feature.

After 1 minute of inactivity, the handset will enter screen saver mode if the handset is not on the base unit or charger.

“Screen saver” will be displayed, and will occasionally change position in order to preserve the life of the display.

Example:

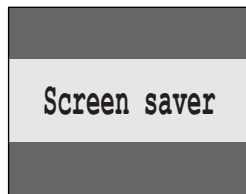

#### To cancel screen saver mode

To use the handset when it is in screen saver mode, first press **[OFF]** to turn the display on again.

## Controls and displays

### Controls

#### Base unit

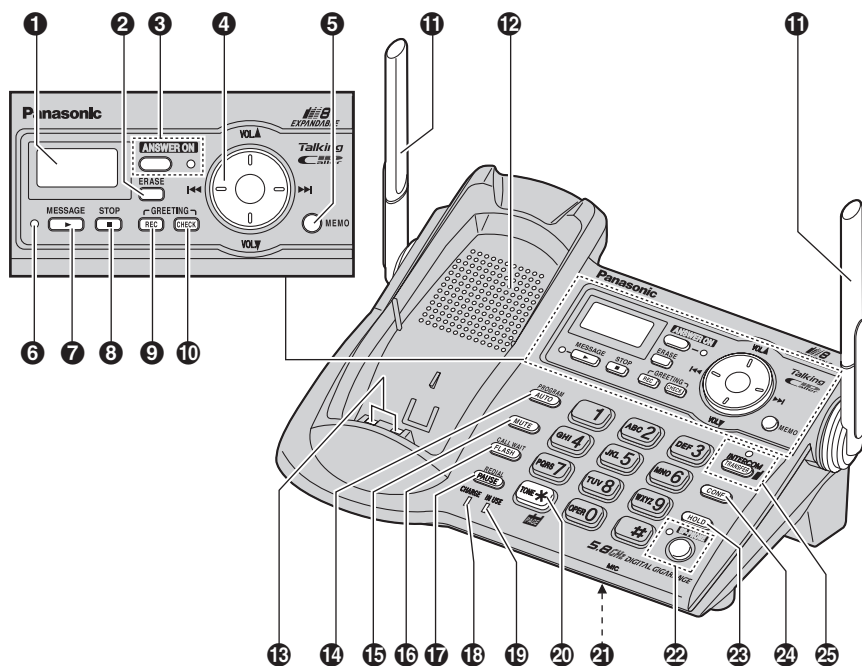

- |                                      |   |
|--------------------------------------|---|
| ① Display                            | ⑭ [PROGRAM] [AUTO]                                |
| ② [ERASE]                            | ⑮ [MUTE]  |
| ③ [ANSWER ON]<br>ANSWER ON indicator | ⑯ [CALL WAIT] [FLASH]                             |
| ④ Navigator key                      | ⑰ [REDIAL] [PAUSE]                                |
| ⑤ [MEMO]                             | ⑱ CHARGE indicator                                |
| ⑥ MESSAGE indicator                  | ⑲ IN USE indicator                                |
| ⑦ [MESSAGE]                          | ⑳ [*] (TONE/FLASH)                                |
| ⑧ [STOP]                             | ㉑ MIC (Microphone)                                |
| ⑨ [GREETING REC] (Recording)         | ㉒ [SP-PHONE] (Speakerphone)<br>SP-PHONE indicator |
| ⑩ [GREETING CHECK]                   | ㉓ [HOLD]  |
| ⑪ Antenna                            | ㉔ [CONF] (Conference)                             |
| ⑫ Speaker                            | ㉕ [INTERCOM] [TRANSFER]<br>INTERCOM indicator     |
| ⑬ Charge contacts                    |   |

## Preparation

### Handset

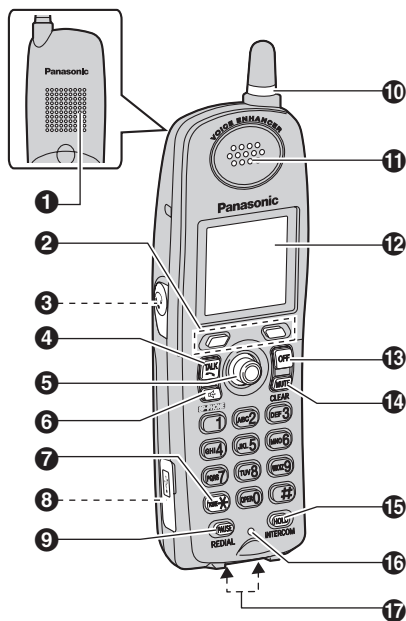

- 1 Speaker
- 2 Soft keys
- 3 Headset jack/Audio jack
- 4 [TALK]
- 5 Joystick
- 6 [SP-PHONE]
- 7 [\*] (TONE)
- 8 USB cable jack (color display models: KX-TG5576 and KX-TGA552 only)
- 9 [REDIAL] [PAUSE]
- 10 Ringer indicator  
Message indicator
- 11 Receiver
- 12 Display
- 13 [OFF]
- 14 [CLEAR] [MUTE]
- 15 [INTERCOM] [HOLD]
- 16 Microphone
- 17 Charge contacts

### Using the joystick

The handset joystick can be used to navigate through menus and to select items shown on the display, by pushing it up, down, left, or right.

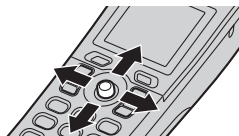

It can also be used to select the center soft key icon (page 18), by pressing down on the center of the joystick.

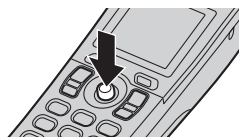



#### Note:

- Up to 5 menu items can be displayed at a time. To select a menu item not shown on the current page, scroll up or down by pushing the joystick up or down, respectively.







## Displays

### Base unit display items

Displayed item	Meaning
	Flashes when the date and time need to be set.
<b>FULL</b>	Flashes when message memory is full.
<b>RINGER OFF</b>	Base unit ringer is off.
<i>E</i>	Greeting or memo message recording error
<i>g</i> 	Answering system is in greeting only mode (caller messages will not be recorded).
<i>H 1</i>	Handset number; displayed when paging or being paged (example shown here: handset 1).
<i>H</i>	Paging all handsets.
<i>P</i>	Base unit is in programming mode.

### Handset display items

Displayed item	Meaning
--:--* <sup>2</sup>	The date and time need to be set.
<b>VE</b>	Voice enhancer is on.
	Battery strength
<b>INUSE</b>	Line is in use. When flashing: a call is on hold. When flashing rapidly: a call is being received.
SP* <sup>1</sup> <b>SP</b> * <sup>2</sup>	Speaker is on.
PRIVACY* <sup>1</sup> <b>PRIVACY</b> * <sup>2</sup>	Call Privacy mode is on.
<b>1</b>	This handset's extension number (example shown here: handset 1)
	You can move the cursor right and left.
	You can scroll or move the cursor right and left or up and down.
	You can scroll up and down.
✓	When customizing the unit: indicates the current setting. When viewing the caller list: indicates that you have called back this caller or viewed this caller information.

\*1 Monochrome display models:  
KX-TG5571 and KXTGA550 only

\*2 Color display models:  
KX-TG5576, KX-TGA551, and KX-TGA552 only

## Preparation







### Handset menu icons

When in standby mode, pushing the center of joystick reveals the handset's main menu. From here you can access various features and settings.







#### Important:

- The menu icons shown in these instructions vary slightly from the actual icons shown on the display.

### Monochrome display models: KX-TG5571 and KX-TGA550 only

Menu icon	Menu/feature
	Answering device
	Ringer setting
	Phonebook
	Function
	Initial setting
	Set date & time

### Color display models: KX-TG5576, KX-TGA551, and KX-TGA552 only

Menu icon	Menu/feature
	Answering device
	Ringer setting
	Display setting
	Function
	Initial setting
	Set date & time

### Handset soft keys

The handset features 2 soft keys and a joystick. By pressing a soft key, or by pressing the center of the joystick, you can select the function displayed directly above it.

- Pressing the left or right soft key selects the leftmost or rightmost soft key icon respectively.
- Pressing the center of the joystick selects the center soft key icon.
- The functions displayed will vary depending on how you are using the unit.
- When a function does not appear above a soft key, the soft key has no function.

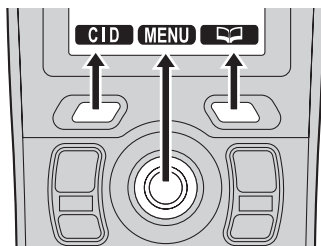

#### Note:

- In these operating instructions, soft key names are written inside brackets, the same way as other unit keys.  
Example:  
Unit keys: **[OFF]**, etc.  
Soft keys: **[CID]**, **[MENU]**, **[**], etc.

### Handset backlit display and handset keypad

The handset display and dialing buttons will light for a few seconds after pressing any of the handset's controls or lifting the handset off the base unit or charger. They will also light when a call is being received.

## Setting the unit before use

### Setting the dialing mode

If you cannot make calls, change this setting depending on your telephone line service. The default setting is "Tone".

"Tone": For tone dial service.

"Pulse": For rotary pulse dial service.

- 1 Press **[MENU]** (center of joystick).
- 2 Scroll to , then press **[SELECT]**.
- 3 Scroll to "set tel line", then press **[SELECT]**.
- 4 Scroll to "set dial mode", then press **[SELECT]**.
- 5 Push the joystick up or down repeatedly to select the desired setting.
- 6 Press **[SAVE]**, then press **[OFF]**.

### Setting the date and time

- 1 Press **[MENU]** (center of joystick).
- 2 Scroll to , then press **[SELECT]**.
- 3 Scroll to "Date and time", then press **[SELECT]**.

Date and time
Time adjustment

- 4 Enter the current month, day, and year by selecting 2 digits for each.  
Example: June 15, 2005  
Press **[0][6] [1][5] [0][5]**.

Date:06.15.2005
Time:12:00 AM
0-9=Date&Time

- 5 Enter the current hour and minute (12-hour clock format) by selecting 2 digits for each.

Example: 9:30 PM

Press **[0][9] [3][0]**.

- 6 Select "AM" or "PM" by pressing **[AM/PM]**.

- 7 Press **[SAVE]**.

- When the date and time are set,  disappears from the base unit display.
- If the handset beeps 3 times, the date and time were not set correctly. Enter the correct digits.

- 8 Press **[OFF]**.

#### Note:

- If you make a mistake when entering the date and time, use the joystick to move the cursor, then make the correction.

#### Time adjustment (Caller ID subscribers only)

When calls are received, Caller ID will automatically adjust the date and time (including daylight saving time).

- If you have not set the date and time manually, Caller ID will not adjust the date and time.
- You can turn this feature off (page 59).

### Making calls using the handset

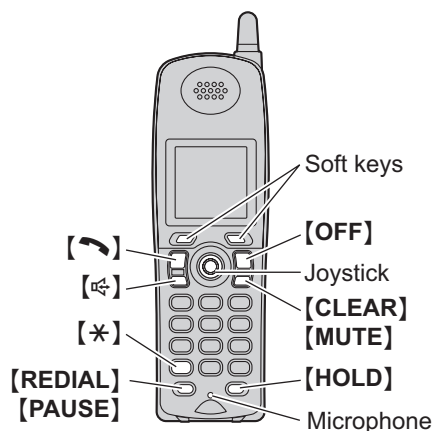

- 1 Lift the handset and press [call icon].
  - “Talk” will be displayed.
- 2 Dial the phone number.
- 3 When finished talking, press [OFF] or place the handset on the base unit or charger.

#### Note:

- The IN USE indicator on the base unit lights while the handset user is on an outside conversation.

#### To adjust the receiver volume

3 levels (high/medium/low) are available. While using the receiver, push the joystick up or down repeatedly.

#### To use the speakerphone

- 1 Lift the handset and press [call icon].
  - “SP-phone” will be displayed.
- 2 Dial the phone number.
- 3 When the other party answers, speak into the microphone.

- 4 When finished talking, press [OFF] or place the handset on the base unit or charger.

#### Note:

- Talk alternately with the caller in a quiet room.
- If the other party has difficulty hearing you, push the joystick down to decrease the speaker volume.
- While on a call, you can switch from the receiver to the speakerphone by pressing [call icon]. To switch back to the receiver, press [call icon].

#### To adjust the speaker volume

6 levels (high to low) are available. While using the speaker, push the joystick up or down repeatedly.

#### To dial after confirming the entered number

- 1 Enter the phone number.
  - To correct a digit, use the joystick to move the cursor, then press [CLEAR]. Enter the correct number.
  - If a pause is required when dialing, press [PAUSE] where needed (page 22).
  - To cancel, press [OFF].

- 2 Press [call icon], [call icon], or [CALL].

- 3 When finished talking, press [OFF] or place the handset on the base unit or charger.

#### To redial the last number dialed

- 1 Press [call icon] or [call icon].
- 2 Press [RECALL].

### To make a call using the redial list

The last 5 phone numbers dialed are stored in the redial list.

- 1 Press **[REDIAL]**.
  - The last number dialed will be displayed.
- 2 Push the joystick up or down repeatedly to display the desired number.
  - To delete the displayed number, press **[CLEAR]**.
  - To exit the list, press **[OFF]**.
- 3 Press **[↶]**, **[↷]**, or **[CALL]**.

### Useful features during a call

#### HOLD button

This feature allows you to put an outside call on hold.

- 1 Press **[HOLD]** during an outside call.
  - To transfer the call to another extension, see page 38.
- 2 Press **[HOLD]** again.
  - “Hold” will be displayed.
  - To return to the call, press **[↶]** or **[↷]**.
  - The base unit user can take the call by pressing **[SP-PHONE]**.
  - Another handset user can take the call by pressing **[↶]** or **[↷]**.

#### Note:

- If another phone is connected on the same line (page 11), you can also take the call by lifting its handset.
- If a call is kept on hold for more than 6 minutes, an alarm tone will start to sound and the ringer indicator will flash rapidly. After 4 additional minutes on hold, the call will be disconnected.

#### MUTE button

You can mute your voice during a conversation. While mute is turned on you will be able to hear the other party, but the other party will not be able to hear you.

To mute your voice, press **[MUTE]**.

- “<Mute>” will flash on the display.
- To return to the conversation, press **[MUTE]**, **[↶]**, or **[↷]**.

#### Voice enhancer

This feature clarifies the voice of the person you are talking to, reproducing a more natural-sounding voice that is easier to hear and understand.

- 1 Press **[MENU]** (center of joystick) during an outside call.
- 2 To turn this feature on or off, press **[3]**.
  - You can also turn this feature on or off by pushing the joystick up or down, then pressing **[SELECT]**.
  - When turned on, **VE** will be displayed.

#### Note:

- Once you turn voice enhancer on, it will be activated for all outside calls until turned off.
- You can also turn this feature on or off by programming (page 52).
- Depending on the condition and quality of your telephone line, this feature may emphasize existing line noise. If it becomes difficult to hear, turn this feature off.

## Making/Answering Calls

---

### Clarity booster

This feature can improve sound clarity when the handset is used in an area where there may be interference. During an outside call, this feature will be turned on automatically when necessary. This feature will turn off when you hang up or put a call on hold. It will not turn off automatically during a call. You can also turn this feature on or off manually.

- 1 Press **[MENU]** (center of joystick) during an outside call.
- 2 To turn this feature on or off, press **[2]**.
  - You can also turn this feature on or off by pushing the joystick up or down, then pressing **[SELECT]**.
  - While this feature is turned on, "Booster on" will flash on the display.

#### Note:

- If this feature is turned off manually during a call, it will not be turned on automatically during the same call.
- While this feature is turned on, battery operating time will be shortened (page 13).
- The maximum number of extensions which can be used at a time may decrease when using this feature.

---

### Call share

When another extension is on an outside call, this feature allows you to join that call. To join a conversation, press **[↶]** or **[↷]** when another extension is on an outside call.

- "Conference" will be displayed.
- A maximum of 4 parties (including the outside party) can join a conversation.

### Call privacy

Call privacy allows you to prevent other users from joining your conversations with outside callers. To allow other users to join your conversations, leave this feature off. This feature is only available for the handset.

To turn this feature on or off, press **[PRIVACY]** during a conversation.

- While this feature is turned on, "PRIVACY" will be displayed.
- While this feature is turned on, other users cannot join the conversation.
- Call privacy will turn off after you hang up the call.

---

### PAUSE button (for PBX/long distance service users)

A pause is sometimes required when making calls using a PBX or long distance service.

For example, if you need to dial the line access number "9" when making outside calls with a PBX:

- 1 Press **[9]**.
- 2 Press **[PAUSE]**, then dial the phone number.

Example:

9P15556667777

- 3 Press **[↶]**, **[↷]**, or **[CALL]**.

#### Note:

- A 3.5 second pause is inserted each time **[PAUSE]** is pressed. Press repeatedly to insert longer pauses.

### FLASH button

Pressing **[FLASH]** allows you to use special features of your host PBX such as transferring an extension call, or accessing optional telephone services such as Call Waiting.

#### Note:

- To change the flash time, see page 57.

### For Call Waiting service users

To use Call Waiting, you must subscribe to your telephone company's Call Waiting service.

This feature allows you to receive calls while you are already talking on the phone. If you receive a call while on the phone, you will hear a Call Waiting tone.

Press **[FLASH]** to answer the 2nd call.

- The 1st call is put on hold while you answer the 2nd call.
- To switch between calls, press **[FLASH]**.

#### Note:

- Please contact your telephone company for details and availability of this service in your area.

### Temporary tone dialing (for rotary/pulse service users)

You can temporarily switch the dialing mode to tone when you need to access touch tone services (for example, answering services, telephone banking services, etc.).

Press **[\*]** (TONE) before entering access numbers which require tone dialing.

#### Note:

- The dialing mode will return to pulse when you hang up.

## Making calls using the base unit

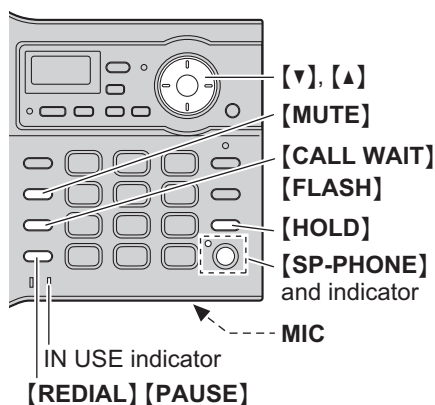

- 1 Press **[SP-PHONE]**.
  - The SP-PHONE and IN USE indicators light.
- 2 Dial the phone number.
- 3 When the other party answers, speak into the MIC.
- 4 When finished talking, press **[SP-PHONE]**.
  - The SP-PHONE and IN USE indicators go out.

#### Note:

- Talk alternately with the caller in a quiet room.
- If the other party has difficulty hearing you, press **[▼]** to decrease the speaker volume.
- While on a call, you can switch from the speaker phone to the handset:
  - If the handset is off the base unit, press **[📞]** or **[📞]** on the handset, then press **[SP-PHONE]** on the base unit.
  - If the handset is on the base unit, simply lift the handset.

## Making/Answering Calls

---

### To adjust the speaker volume

8 levels (high to low) are available.  
While on a call press **[▼]** or **[▲]** repeatedly.

### To redial the last number dialed

**1** Press **[SP-PHONE]**.

**2** Press **[REDIAL]**.

## Useful features during a call

---

### HOLD button

This feature allows you to put an outside call on hold.

Press **[HOLD]** during an outside call.

- The SP-PHONE indicator and IN USE indicator flash.
- To return to the call, press **[SP-PHONE]**.
- The handset user can take the call by pressing **[📞]** or **[📞]**.

### Note:

- If another phone is connected on the same line (page 11), you can also take the call by lifting its handset.
- If a call is kept on hold for more than 6 minutes, an alarm tone will start to sound. After 4 additional minutes on hold, the call will be disconnected.

### MUTE button

You can mute your voice during a conversation. While mute is turned on you will be able to hear the other party, but the other party will not be able to hear you.

To mute your voice, press **[MUTE]**.

- The SP-PHONE indicator flashes.
- To return to the conversation, press **[MUTE]** or **[SP-PHONE]**.

### Call share

When another extension is on an outside call, this feature allows you to join that call. To join a conversation, press **[SP-PHONE]** when another extension is on an outside call.

- A maximum of 4 parties including the outside party can join a conversation.

### FLASH button

Pressing **[FLASH]** allows you to use special features of your host PBX such as transferring an extension call, or accessing optional telephone services such as Call Waiting.

### Note:

- To change the flash time, see page 57.

### For Call Waiting service users

To use Call Waiting, you must subscribe to your telephone company's Call Waiting service.

This feature allows you to receive calls while you are already talking on the phone. If you receive a call while on the phone, you will hear a Call Waiting tone.

Press **[CALL WAIT]** to answer the 2nd call.

- The 1st call is put on hold while you answer the 2nd call.
- To switch between calls, press **[CALL WAIT]**.

### Note:

- Please contact your telephone company for details and availability of this service in your area.



### Temporary tone dialing (for rotary/pulse service users)

You can temporarily switch the dialing mode to tone when you need to access touch tone services (for example, answering services, telephone banking services, etc.).

Press **[\*]** (TONE) before entering access numbers which require tone dialing.



#### Note:

- The dialing mode will return to pulse when you hang up.

---

## Answering calls using the handset

When a call is being received, the ringer indicator flashes rapidly.

- 1** Lift the handset and press **[ or **[.
  - You can also answer a call by pressing any button except the joystick or **[OFF]**. (**Any key talk feature**)****
- 2** When finished talking, press **[OFF]** or place the handset on the base unit or charger.

---

### Auto talk

This feature allows you to answer a call by simply lifting the handset off the base unit or charger. You do not need to press **[]. To activate this feature, see page 56.**

---

### Temporary ringer off

While the handset is ringing for an outside call, you can turn the ringer off temporarily by pressing **[OFF]**. The handset will ring the next time a call is received.

---

### Answering calls using the base unit

When a call is being received, the IN USE indicator flashes rapidly.

- 1 Press **[SP-PHONE]**.
- 2 Speak into the MIC.
- 3 When finished talking, press **[SP-PHONE]**.

---

### Adjusting the ringer volume

4 levels (high/medium/low/off) are available.

While the base unit is not being used, press **[▼]** or **[▲]** repeatedly to select the desired volume.

- To stop ringing, press **[STOP]**.

To turn the ringer off, press and hold **[▼]** until the base unit beeps 2 times.

- **RINGER OFF** will be displayed.

#### Note:

- When the ringer volume is set to off, the base unit will not ring for outside calls and it will ring at the low level for intercom calls.
- When the ringer volume is set to off, the base unit will not announce caller names (page 33).

---

### Changing the ringer tone

You can change the base unit ringer tone heard when an outside call is received. There are 3 tones and 4 melodies.

- 1 Press **[▲]** or **[▼]**.
- 2 Within 10 seconds, press **[◀]** or **[▶]** repeatedly to select the desired ringer tone.
  - To stop ringing, press **[STOP]**.

#### Note:

- If you subscribe to a distinctive ring service (such as IDENT-A-RING), select a tone (Tone 1 to 3). If you select a melody, you will not be able to distinguish lines by their ringers.
- If you select one of the melody ringer patterns, the ringer will continue to sound for several seconds if:
  - the caller hangs up before you answer the call.
  - another person answers the call using another phone connected on the same line.

## Handset phonebook

The handset phonebook allows you to make calls without having to dial manually. You can add 50 names and phone numbers to the handset phonebook and search for phonebook entries by name.

### Important:

- KX-TG5576 and KX-TGA552 only: You can also create and edit phonebook items using your PC and send them to the handset. Refer to the help section of the GIGARANGE USB Utility software for details. If you have not installed the GIGARANGE USB Utility software, refer to the included "Installation Guide for GIGARANGE USB Utility" for details.

## Adding items to the phonebook

**1** Press **[]** (right soft key).

- The display shows the number of items in the phonebook.

**2** Press **[ADD]**.

Enter name

**3** Enter the name (max. 16 characters). See the character table for entry.

**4** Press **[NEXT]**.

Enter phone no.

**5** Enter the phone number (max. 32 digits).

- If a pause is required when dialing, press **[PAUSE]** where needed (page 22).

**6** Press **[NEXT]**.

- If you want to change the name and number, press **[EDIT]**, then repeat from step 3.

Example:

Tom  
555-765-4321

**7** Press **[SAVE]**.

- To add other items, repeat from step 2.

**8** Press **[OFF]**.

### Note:

- Caller ID subscribers can use ringer ID and light-up ID features (page 33).
- Color display models (KX-TG5576 and KX-TGA552 only):  
Caller ID subscribers can use picture ID (page 34).

### Character table

The dial keys can be used to enter characters. To enter a character, press the appropriate dial key, repeatedly if necessary. To enter another character that is located on the same dial key, first push the joystick right to move the cursor to the next space.

Key	Characters
[1]	& ' ( ) , - . / 1
[2]	a b c A B C 2
[3]	d e f D E F 3
[4]	g h i G H I 4
[5]	j k l J K L 5
[6]	m n o M N O 6
[7]	p q r s P Q R S 7
[8]	t u v T U V 8
[9]	w x y z W X Y Z 9
[0]	0 Space

## Phonebook

Key	Characters
[*]	*
[#]	#
[CLEAR]	To delete a character or number

### To edit/correct a mistake



Use the joystick to move the cursor to the character or number you wish to erase, then press **[CLEAR]**. Enter the appropriate character or number.

### Note:

- Press and hold **[CLEAR]** to erase all characters or numbers.



## Calling someone in the phonebook

Phonebook items can be searched for alphabetically by scrolling through the phonebook items.

- 1 Press **[ (right soft key).
  - To view the first item, press **[SEARCH]**.**
- 2 Push the joystick up or down repeatedly to display the desired item.
  - To exit the phonebook, press **[OFF]**.
- 3 Press **[], **[], or **[CALL]**.****

### To search for a name by initial

- 1 Press **[] (right soft key).**
- 2 Press the dialing button (**[0]** to **[9]**, **[#]**, or **[\*]**) which corresponds to the first letter you are searching for (see the character table, page 27).  
Example: "LISA"  
Press **[5]** repeatedly to display any name with the initial "L".
  - If there is no item corresponding to the letter you selected, the next item will be displayed.

- 3 Push the joystick down repeatedly to display the desired item.
  - To exit the phonebook, press **[OFF]**.
  - To dial the displayed number, press **[], **[], or **[CALL]**.****

## Adding items/calling someone in the phonebook using the unit's menu (Monochrome display models only)

### Important:

- Only the KX-TG5571 and KX-TGA550 support this feature.

Monochrome display model users can also enter the phonebook from the handset's main menu.

- 1 Press **[MENU]** (center of joystick).
- 2 Scroll to **[], then press **[SELECT]**.
  - The display shows the number of items in the phonebook.**
- 3 To add items, continue from step 2 of "Adding items to the phonebook" on page 27.  
OR  
To call someone, continue from step 2 of "Calling someone in the phonebook".

## Editing items in the phonebook

- 1 Press [**BOOK**] (right soft key).
- 2 Push the joystick up or down repeatedly to display the desired item.
- 3 Press [**EDIT**].
- 4 Edit the name if necessary. See the character table on page 27 for character entry.
- 5 Press [**NEXT**].
- 6 Edit the phone number if necessary.
- 7 Press [**NEXT**], then press [**SAVE**].
  - To edit other items, repeat from step 2.
- 8 Press [**OFF**].

## Erasing items in the phonebook

- 1 Press [**BOOK**] (right soft key).
- 2 Push the joystick up or down repeatedly to display the desired item.
- 3 Press [**CLEAR**].
  - To cancel erasing, press [**NO**].
- 4 Press [**YES**].
  - To erase other items, repeat from step 2.
- 5 Press [**OFF**].

## Chain dial feature

This feature allows you to dial phone numbers from the phonebook while you are on a call.

Example: Using a long distance calling card

- ① Dial from the phonebook:  
1-800-012-3456 (Calling card access number).
- ② When prompted, dial from the phonebook:  
1234 (Calling card PIN).
- ③ When prompted, dial from the phonebook:  
1-555-012-3456 (the person you want to call).

**1 During an outside call, press [MENU]** (center of joystick).

**2 Press [1]** to select "Phonebook".

**3 Push the joystick up or down repeatedly to display the desired item.**

- To search for the item by initial, see page 28.

**4 Press [CALL].**

- Repeat from step 1 to dial other numbers.

### Note:

- When storing a calling card access number and your PIN in the phonebook as one phonebook item, press [**PAUSE**] to add pauses after the number and PIN as necessary (page 22).
- If you have rotary or pulse service, you need to press [**\***] before pressing [**MENU**] in step 1 to change the dialing mode temporarily to tone.

## Copying phonebook items

You can copy one or all of the phonebook items from the handset to the phonebook of a compatible Panasonic handset (page 6).

### Important:

- Make sure the destination handset is not in use.
- Do not place your handset on the base unit or charger until copying has finished, otherwise copying will stop.
- If an outside call is received during the phonebook copy, copying will stop. You will need to copy the item(s) later.
- Ringer ID and light-up ID settings for phonebook items are not copied (page 33).
- Color display models (KX-TG5576 and KX-TGA552 only):  
Picture ID settings for phonebook items are not copied (page 34).

---

## Copying an item

- 1 Press [] (right soft key).
- 2 Press [**COPY**].
- 3 Scroll to "1 item", then press [**SELECT**].
- 4 Scroll to the destination handset's number, then press [**SELECT**].
- 5 Push the joystick up or down repeatedly to display the desired item.
  - To search for the item by initial, see page 28.
- 6 Press [**SEND**].
  - When the item has been copied, "Complete" will be displayed.
  - The destination handset display will show "Phonebook Receiving", then "Phonebook Received".
  - To copy another item, repeat from step 5.

- 7 Press [**OFF**].

---

## Copying all items

- 1 Press [] (right soft key).
- 2 Press [**COPY**].
- 3 Scroll to "All items", then press [**SELECT**].
- 4 Scroll to the destination handset's number, then press [**SEND**].
  - When all items have been copied, "Complete" will be displayed.
  - The destination handset display will show "Phonebook Receiving", then "Phonebook Received".
  - To copy items to another handset, repeat from step 3.
- 5 Press [**OFF**].

---

## Base unit speed dialer

The base unit speed dialer allows you to make calls without having to dial manually. You can assign one phone number to each of the 10 dial keys ([0] to [9]) on the base unit.

---

### Adding phone numbers to the speed dialer

#### Important:

- Before storing phone numbers, make sure the base unit is not being used.

- 1 Press **[PROGRAM]**.
  - The IN USE indicator will flash.
- 2 Enter the phone number (max. 32 digits).
  - If a pause is required for dialing, press **[PAUSE]** where needed.
  - If you misdial, press **[STOP]** and repeat from step 1.
- 3 Press **[PROGRAM]**.
- 4 Press a dial key ([0] to [9]).
  - The base unit will beep.
  - To store other phone numbers, repeat from step 1.

#### Note:

- If a phone number is stored in a dial key which already contains a phone number, the old number will be erased.
- We recommend you make a note of which phone numbers are stored in which dial keys.

---

#### PAUSE button (for PBX/long distance service users)

A pause is sometimes required when making calls using a PBX or long distance service.

For example, if you need to dial the line access number "9" with a PBX:

In step 2, press **[9]**, **[PAUSE]**, then enter the phone number.

#### Note:

- A 3.5 second pause is inserted each time **[PAUSE]** is pressed. Press repeatedly to insert longer pauses. "P" is displayed when **[PAUSE]** is pressed.
- When **[\*]** is pressed, "L" is displayed. When **[#]** is pressed, "E" is displayed.

---

#### To erase a stored phone number

- 1 Press **[PROGRAM]** 2 times.
- 2 Press the desired dial key ([0] to [9]).
  - The base unit will beep.

---

### Calling someone with the speed dialer

- 1 Press **[SP-PHONE]**.
- 2 Press **[AUTO]**.
- 3 Press the desired dial key ([0] to [9]).
  - The stored phone number will be dialed.

#### Note:

- Speed dial numbers stored in the base unit can only be dialed from the base unit.

### Using Caller ID service

This unit is Caller ID compatible. To use Caller ID features, you must subscribe to your telephone company's Caller ID service.

#### Caller ID features

When an outside call is being received, the calling party's name and telephone number will be displayed.

Example:



BROWN, NANCY  
1-555-666-7777

Caller information for the last 50 different callers will be logged in the caller list, allowing you to return missed calls. Caller information is stored by the most recent call to the oldest.

- When Caller ID information is received and it matches a phone number stored in the phonebook, the handset will use the ringer tone and the ringer indicator color you assigned to the caller. (**Ringer ID and light-up ID**)
- Color display models (KX-TG5576 and KX-TGA552 only):  
When Caller ID information is received and it matches a phone number stored in the phonebook, the handset will display the picture you assigned to the caller. (**Picture ID**)
- While listening to a message recorded by the answering system, using the handset, you can call back the caller without having to dial the phone number (page 64).
- If the unit cannot receive caller information, the following will be displayed:  
“**Out of area**”: The caller dialed from an area which does not provide Caller ID service.  
“**Private caller**”: The caller requested not to send caller information.

“**Long distance**”: The caller called you long distance.

- If the unit is connected to a PBX system, caller information may not be received properly. Consult your PBX supplier.

#### Call Waiting Caller ID display

If you subscribe to both Caller ID and Call Waiting with Caller ID services, the 2nd caller's information will be displayed after you hear a Call Waiting tone (page 23).

#### Note:

- Please contact your telephone company for details and availability of this service in your area.

### Talking Caller ID

This feature allows you to know who is calling without looking at the display. When a call comes in, the handset and base unit will announce the caller's name displayed on the handset following every ring.

To use this feature, you must subscribe to your telephone company's Caller ID service.

- If the unit does not receive Caller ID information, the unit will announce “*Call from out of area*”, “*Call from private caller*”, or “*Call from long distance*”.
- If a call is received from an area where name display service is not available, “*Number available*” will be announced.
- Name pronunciation may vary. This feature may not pronounce all names correctly.
- The unit will announce each letter of abbreviations, such as “Co.” and “Inc.”.
- Caller ID supports names of up to 15 letters. If the caller's name has more than 15 letters, the name will not be displayed or announced correctly.
- If you subscribe to a distinctive ring service (such as IDENT-A-RING), your unit may mute one or more of the rings in order to announce the name of the caller.



- If the ringer volumes of the handset and base unit are turned off, caller names will not be announced. The announcement is heard at the ringer volume (page 26, 49).
- When you receive a call while on the phone, the 2nd caller's name will not be announced even if you subscribe to both Caller ID and Call Waiting with Caller ID services.
- If this feature is turned off, caller names will not be announced (page 55, 58).
- Usually the unit will announce the caller's name after the 2nd ring. If you turn on the answering system, and set the ring count to "2" (page 68), the unit will not announce the caller's name. If "Toll saver" is selected, and there is a new message, the unit will not announce the caller's name.
- If an outside call is received while on an intercom call between the handset and base unit, the other handsets will ring, but the caller's name will not be announced.

### Ringer ID and light-up ID

This feature can help you identify who is calling by using different ringers and ringer indicator colors for different callers stored in the phonebook. You can assign a different ringer and indicator color to each phonebook item. When a call is received from a caller stored in the phonebook, the ringer and indicator color are used after Caller ID information is displayed.

- Usually the ringer and indicator color will be changed from the 2nd ring.

### Ringer ID

You can assign a different ringer tone to each caller in the phonebook. If you select "No Ringer ID" (default), the unit will use the ringer tone you set on page 49 when a call is received from that caller.

- 1 Press **[]** (right soft key).
- 2 Push the joystick up or down repeatedly to display the desired item.
- 3 Press **[OPTION]**.
- 4 Press **[1]** to select "Ringer ID".
- 5 To select a tone or melody, scroll to "Tone & Melody", then press **[SELECT]**.  
OR  
To select a song, scroll to "Customized ring", then press **[SELECT]**.
- 6 Push the joystick up or down repeatedly to select the desired item.
- 7 Press **[SAVE]**, then press **[OFF]**.

#### Note:

- To erase a song, see page 51 and 53. If you erase a song assigned to a caller, the Ringer ID assignment will be canceled, and the handset ringer tone (page 49) will be used instead of that song.

## Caller ID Service

---

### Light-up ID

You can assign a different ringer indicator color to each caller in the phonebook.

Select "Color1" (amber), "Color2" (blue), "Color3" (green), or "Multicolor".

If you select "No Light-upID" (default), the unit will use the ringer color you set on page 51 when a call is received from that caller.

- 1 Press [**☰**] (right soft key).
- 2 Push the joystick up or down repeatedly to display the desired item.
- 3 Press [**OPTION**].
- 4 Press [**2**] to select "Light-up ID".
- 5 Push the joystick up or down repeatedly to select the desired ringer indicator color.
- 6 Press [**SAVE**], then press [**OFF**].

---

### Picture ID (Color display models only)

#### Important:

- Only the KX-TG5576 and KX-TGA552 support this feature.

You can assign a picture to each caller in the phonebook. When a call is received from a caller stored in the phonebook, the picture is displayed after Caller ID information is received.

- Usually the picture will be displayed from the 2nd ring.

There are 5 preset pictures.

You can also download picture data for callers from a PC. Refer to the help section of the GIGARANGE USB Utility software for details. If you have not installed the GIGARANGE USB Utility software, refer to the included "Installation Guide for GIGARANGE USB Utility" for details.

- 1 Press [**☰**] (right soft key).
- 2 Push the joystick up or down repeatedly to display the desired item.
- 3 Press [**OPTION**].
- 4 Press [**3**] to select "Picture ID".
- 5 To select a preset picture, scroll to "Fixed data", then press [**SELECT**].  
OR  
To select your original picture, scroll to "User data", then press [**SELECT**].
- 6 Push the joystick up or down repeatedly to select the desired picture.
  - To view the picture name, press [**LIST**]. To return to the picture, press [**VIEW**].
- 7 Press [**SAVE**], then press [**OFF**].

#### Note:

- To cancel the Picture ID assignment, select "No data" in step 5, then press [**SELECT**].
- To erase your original picture, see page 53. If you erase a picture assigned to a caller, the Picture ID assignment will be canceled.

## Caller list

Caller information for the last 50 different callers will be logged in the caller list. You can use this list to return missed calls.

- Caller information includes caller names and phone numbers, the date and time of calls, and the number of times the caller called.

### Missed calls

If a call is not answered, the unit treats the call as a missed call. The number of missed calls is shown on the handset display. This lets you know if you should view the caller list to see who called while you were out.

- If there are no items in the caller list, **[CID]** will not be displayed.

## Viewing the caller list and calling back

- 1 Press **[CID]** (left soft key).
- 2 Push the joystick down repeatedly to search from the most recent call, or up to search from the oldest call.
  - To exit the caller list, press **[OFF]**.
- 3 Press **[↶]** or **[↷]**.

### Note:

- Calling back will not be possible if the caller information does not include a phone number.
- In some cases, you may have to edit the number before dialing. (For example, you may have to delete "1" and the area code.)
- Each handset has its own caller list. If you viewed the caller list or answered a call on one handset, the same information in the other handsets will be displayed as **"missed calls"**.

## Displayed symbols

- If the same caller calls more than once, it will be displayed with the number ("x2" to "x9"). Only the date and time of the most recent call will be stored.
- A ✓ is displayed next to items which have already been viewed or answered on this handset.

## Editing a caller's phone number before calling back

You can edit a phone number in the caller list by removing its area code and/or the long distance code "1".

- 1 Press **[CID]** (left soft key).
- 2 Push the joystick up or down repeatedly to display the desired item.
- 3 Press **[EDIT]** repeatedly until the phone number is shown in the desired format.
 

Each time you press **[EDIT]**, the phone number will be rearranged into one of 3 patterns.

  - ① Local phone number  
Example:
  - ② Area code – Local phone number  
Example:
  - ③ 1 – Area code – Local phone number  
Example:
- 4 Press **[↶]** or **[↷]** to call back.

## Caller ID Service

---

### Caller ID number auto edit feature

Once you call back an edited number (see "Editing a caller's phone number before calling back" on page 35), the unit can automatically edit other incoming phone numbers each time you receive a call.

For example, you can use this feature to set the unit to ignore the area code of callers in your area code, so that you can call these local numbers using caller information without dialing the area code. To activate this feature, you must edit an item in the caller list (see "Editing a caller's phone number before calling back" on page 35), then call that number. After that, calls from that caller's area code will be edited automatically.

This feature can be turned on or off (page 55). The default setting is ON.

#### Note:

- The handset can remember up to 4 area codes to be edited. Phone numbers from the 4 most recently edited area codes will be automatically edited.
- This feature will not be activated until edited numbers are called back.
- If you move to another area, you can turn this feature off to erase previously edited area codes. To use this feature again, turn it on and reprogram the area codes you want to edit once again.

---

### Storing caller information into the phonebook

Items in the caller list can be stored into each handset's phonebook.

- 1 Press **[CID]** (left soft key).
- 2 Push the joystick up or down repeatedly to display the desired item.
  - To edit the number, press **[EDIT]** repeatedly until the number is shown in the desired format (see "Editing a caller's phone number before calling back" on page 35, step 3).

- 3 Press **[SAVE]**.
  - If there is no name information for the caller, "**Enter name**" will be displayed.
    - ① Enter the name if necessary (see page 27, step 3).
    - ② Press **[NEXT]**, then press **[SAVE]**.
  - To continue storing other items, repeat from step 2.

- 4 Press **[OFF]**.

#### Note:

- If the caller information does not include a phone number, you cannot store it in the phonebook.

---

## Erasing caller information

---

### Erasing a selected item

- 1 Press **[CID]** (left soft key).
- 2 Push the joystick up or down repeatedly to display the desired item.
- 3 Press **[CLEAR]**.
  - To erase other items, repeat from step 2.
  - To exit the caller list, press **[OFF]**.

---

### Erasing all items

Make sure that you have no missed calls.

- 1 Press **[CID]** (left soft key).
- 2 Press **[ERASE]** or **[CLEAR]**.
  - "**All erase?**" will be displayed.
  - To cancel erasing, press **[NO]**.
- 3 Press **[YES]**.

## Intercom

Intercom calls can be made between the handset and the base unit, and between the included handset and a compatible Panasonic handset (page 6).

Call the desired unit by selecting the extension number (**1** to **8**), shown in the upper right of each handset's display. The base unit's extension number is 0.

- The base unit will display the paging or paged handset's extension number (*H 1* to *H 8*).

### Note:

- If you have difficulty hearing the other party while using the speaker, decrease the speaker volume.
- If you receive a phone call while talking on the intercom, you will hear 2 tones (page 56, 58). To answer the call with the handset, press **[OFF]**, then press **[↶]** or **[↷]**. To answer the call with the base unit, press **[SP-PHONE]** 2 times.
- You cannot change the ringer tone for intercom calls.

### From the handset to the base unit

#### 1 Handset:

Press **[INTERCOM]**, then press **[0]**.

- The base unit will beep for 1 minute.
- To stop paging, press **[OFF]**.

#### 2 Base unit:

Press **[SP-PHONE]** or **[INTERCOM]** to answer the page.

#### 3 Handset:

When finished talking, press **[OFF]**.

### Note:

- During an intercom call, the handset user can switch to the speaker by pressing **[↷]**. To switch back to the receiver, press **[↶]**.

### From the base unit to a handset

#### 1 Base unit:

Press **[INTERCOM]**.

#### 2 To page a specified handset, press its extension number (**[1]** to **[8]**).

OR

To page all handsets, press **[0]**.

- The handset(s) will beep for 1 minute.
- To stop paging, press **[SP-PHONE]** or **[INTERCOM]**.

#### 3 Handset:

Press **[↶]**, **[↷]**, or **[INTERCOM]** to answer the page.

#### 4 Base unit:

When the paged party answers, speak into the MIC.

#### 5 Base unit:

When finished talking, press **[SP-PHONE]** or **[INTERCOM]**.

### Note:

- You can locate a misplaced handset by paging it. (**Handset locator**)
- If you page all handsets, only the handset user who answers first can talk with the base unit.

### From one handset to another handset

Example: When handset 1 calls handset 2.

#### 1 Handset 1:

Press **[INTERCOM]**, then press the handset's extension number **[2]** (desired handset number).

- The paged handset will beep for 1 minute.
- To stop paging, press **[OFF]**.

#### 2 Handset 2:

Press **[↶]**, **[↷]**, or **[INTERCOM]** to answer.

#### 3 When finished talking, press **[OFF]**.

### Voice paging

The base unit user can make a voice announcement that is heard through the speakers of all handsets.

- 1 Press **[INTERCOM]**, then press **[\*]** ().
  - You will hear a ringback tone (2 short beeps) and the SP-PHONE indicator will flash.
- 2 When the SP-PHONE indicator stops flashing, speak into the MIC.
  - All handset users will hear your voice through their speakers after beeps.
- 3 When finished, press **[SP-PHONE]** or **[INTERCOM]**.  
OR  
After one of the handsets answers, talk into the MIC. When finished talking, press **[SP-PHONE]** or **[INTERCOM]**.

#### Note:

- To answer the voice page with a handset, press **[↶]**, **[↷]**, or **[INTERCOM]**. Only the handset user who answers first can talk with the base unit user.
- A handset user can mute the current voice announcement by placing the handset on the base unit or charger, or by pressing **[OFF]**. Other handsets will continue to hear the announcement.
- If a handset is too close to the base unit, you may hear feedback while making the voice announcement. Place the handset on the base unit or charger or press **[OFF]**.
- The announcement is heard at the handset ringer volume (page 49).
- A handset cannot be paged when it is on the base unit.

### Transferring a call

Outside calls can be transferred between the handset and the base unit, and between the handset and a compatible Panasonic handset (page 6).

#### Transferring a call from the handset

- 1 During an outside call, press **[INTERCOM]**.
  - The call will be put on hold.
- 2 To page the base unit, press **[0]**.  
To page another handset, press its extension number (**[1]** to **[8]**).
- 3 Wait for the paged party to answer.
  - The base unit user can answer by pressing **[SP-PHONE]** or **[INTERCOM]**.
  - The paged handset user can answer by pressing **[↶]**, **[↷]**, or **[INTERCOM]**.
  - If there is no answer, press **[↶]** or **[↷]** to return to the outside call.
- 4 To complete the transfer, press **[OFF]**.

#### Transferring a call without speaking to the paged party

- 1 During an outside call, press **[INTERCOM]**.
- 2 To page the base unit, press **[0]**.  
To page another handset, press its extension number (**[1]** to **[8]**).
- 3 Press **[OFF]**.
  - The outside call rings at the paged unit.

#### Note:

- If the paged party does not answer the call, press **[↶]** or **[↷]** to return to the call. If not answered within 1 minute, the

call will ring at your handset again. If you still do not answer the call within 4 minutes, the call will be disconnected.

---

### Transferring a call from the base unit

#### Important:

- When you page all handsets, only the handset user who answers first can take the transferred call.

- 1** During an outside call, press **[INTERCOM]**.
  - The call will be put on hold.
- 2** To page a specified handset, press its extension number (**[1]** to **[8]**). To page all handsets, press **[0]**. To make a voice announcement to all handsets, press **[\*]** (**[MUTE]**), then speak into the MIC when the SP-PHONE indicator stops flashing.
- 3** Wait for the paged party to answer.
  - The paged handset user can answer by pressing **[hook]**, **[MIC]**, or **[INTERCOM]**.
  - If there is no answer, press **[INTERCOM]** to return to the outside call.
- 4** To complete the transfer, press **[SP-PHONE]**.

---

### Transferring a call without speaking to the paged party

- 1** During an outside call, press **[INTERCOM]**.
- 2** To page a specified handset, press its extension number (**[1]** to **[8]**). To page all handsets, press **[0]**. To make a voice announcement to all handsets, press **[\*]** (**[MUTE]**), then speak into the MIC when the SP-PHONE indicator stops flashing.

### **3** Press **[SP-PHONE]**.

- The outside call rings at the paged handset(s).

#### Note:

- If the paged party does not answer the call, press **[SP-PHONE]** to return to the call. If not answered within 1 minute, the call will ring at the base unit again. If you still do not answer the call within 4 minutes, the call will be disconnected.

---

### Transferring a call to the answering system

When you answer a call and the caller wants to talk to someone who is not available, you can transfer the caller to the answering system where the caller can leave a message.

Tell the caller beforehand that you will transfer him or her to the answering system.

#### **1** Handset:

Press **[INTERCOM]** during an outside call.  
OR

#### Base unit:

Press **[TRANSFER]** during an outside call.

- The call will be put on hold.

#### **2** Press **[9]** to hang up the call.

- After you press **[9]**, the caller will hear the greeting message, then the caller can leave a message (page 60).

### Conference calls

A conference call allows the handset and the base unit or a compatible Panasonic handset (page 6) to speak together with an outside party.

#### Using the handset

- 1 During an outside call, press **[INTERCOM]**.
  - The call will be put on hold.
- 2 To page the base unit, press **[0]**. To page another handset, press its extension number (**[1]** to **[8]**).
- 3 When the paged party answers, press **[CONF]** on your handset to establish a conference call.
  - “Conference” will be displayed.
  - To leave the conference, press **[OFF]**. The other parties can continue the conversation.

#### Note:

- The outside call can be put on hold by pressing **[HOLD]** during a conference call. Communications between extensions are not suspended. Only the person who placed the call on hold can resume the conference by pressing **[CONF]**.
- One more extension can join the conference call. To join a conference call using the base unit, press **[SP-PHONE]**. To join using a handset, press **[↶]** or **[↷]**. A maximum of 4 parties can join a conference call.
- If 2 handsets are in a conference call and one handset is using the clarity booster feature, a 3rd handset will not be able to join the conference call.

### Using the base unit

- 1 During an outside call, press **[INTERCOM]**.
  - The call will be put on hold.
- 2 To page the desired handset, press its extension number (**[1]** to **[8]**).
- 3 When the paged party answers, press **[CONF]** on your base unit to establish a conference call.
  - To leave the conference, press **[SP-PHONE]**. The other parties can continue the conversation.

#### Note:

- The outside call can be put on hold by pressing **[HOLD]** during a conference call. Communications between extensions are not suspended. Only the person who placed the call on hold can resume the conference by pressing **[CONF]**.
- One more extension can join the conference call. To join the conference call using a handset, press **[↶]** or **[↷]**.



## Room monitor

This feature allows you to listen in on a room where the handset or base unit is located. The monitored extension will not ring, allowing you to easily monitor, for example, a baby's room from different areas of the house. If you want to prevent your unit from being monitored by other extensions, leave this feature OFF (default).

### Setting room monitor

#### Turning on/off the handset's room monitor feature

This allows the handset to be monitored.

- 1 Press **[MENU]** (center of joystick).
- 2 Scroll to , then press **[SELECT]**.
- 3 Scroll to "Room monitor", then press **[SELECT]**.
- 4 Push the joystick up or down repeatedly to select "On" or "Off".
- 5 Press **[SAVE]**, then press **[OFF]**.



#### Turning on/off the base unit's room monitor feature

This allows the base unit to be monitored. This feature must be set by using the handset.



- 1 Press **[MENU]** (center of joystick).
- 2 Scroll to , then press **[SELECT]**.
- 3 Scroll to "Set base unit", then press **[SELECT]**.
- 4 Scroll to "Room monitor", then press **[SELECT]**.
- 5 Push the joystick up or down repeatedly to select "On" or "Off".
- 6 Press **[SAVE]**, then press **[OFF]**.

## Monitoring a room

### Important:

- Before monitoring, make sure the unit to be monitored is not in use.
- The handset to be monitored must be off the base unit.
- If you receive a phone call while monitoring a room, you will hear 2 tones (page 56, 58). To answer the call with the handset, press **[OFF]**, then press  or . To answer the call with the base unit, press **[SP-PHONE]** 2 times.

### Monitoring with the handset

- 1 Press **[INTERCOM]**, then press **[MONITOR]**.
- 2 To call the base unit, press **[0]**. To call another handset, press its extension number (**[1]** to **[8]**).
  - Your handset will start to monitor the room through the destination unit.
  - To monitor from the speaker, press . To switch back to the receiver, press .
- 3 To end monitoring, press **[OFF]**.
  - The base unit user can stop being monitored by pressing **[INTERCOM]** or **[SP-PHONE]**. The monitored handset user can stop being monitored by pressing **[OFF]**.

### Note:

- The monitored handset displays "Room monitor".

## Intercom Features

---

### Monitoring with the base unit

- 1** Press **[INTERCOM]**, then press **[MUTE]**.
- 2** To call the desired handset, press its extension number (**[1]** to **[8]**).
  - The base unit will start to monitor the room through the handset.
- 3** To end monitoring, press **[INTERCOM]** or **[SP-PHONE]**.
  - The monitored handset user can stop being monitored by pressing **[OFF]**.

#### Note:

- The monitored handset displays “Room monitor”.
- If the room monitor feature of the destination handset is off or if that handset is on the base unit, a busy tone will be heard.

## Guide to handset programming

For your reference, a chart of all programmable functions is printed below. Details for each item can be found on the corresponding pages. To program, press **[MENU]** (center of joystick), push the joystick up, down, left, or right to scroll through the menu, and press **[SELECT]** when the desired menu item or setting is displayed.





### Important:

- Before programming, make sure the handset and base unit are not being used. The handset must be operated near the base unit and while off the base unit or charger.
- You can also program features using “direct commands”—special codes that take you directly to the feature you wish to program and allow you to select the desired setting (page 46).



### During programming:

- To exit programming, press **[OFF]** at any time.
- To go to next page, press **[NEXT]**.
- To go back to the top of the menu, press **[TOP]**.
- To go back to the previous menu, press **[BACK]**, or push the joystick left.



### Monochrome display models: KX-TG5571 and KX-TGA550 only

Main menu	Sub-menu 1	Sub-menu 2	Page
<b>Answering device</b> 	Message playback	–	63
	Message alert	–	69
	Ring count <sup>*1</sup>	–	68
	Recording time <sup>*1</sup>	–	69
	Remote code <sup>*1</sup>	–	67
	Call screening <sup>*1</sup>	–	69
<b>Ringer setting</b> 	Ringer volume	–	49
	Ringer tone	–	49
	Customize ring	–	50
	Ring color	–	51
<b>Phonebook</b> 	–	–	28
<b>Function</b> 	Voice enhancer	–	52
	Caller IQ <sup>*2</sup>	View Info.? <sup>*2</sup>	–
		Get new Info.? <sup>*2</sup>	–
		Turn CIQ off? <sup>*2</sup>	–
Customer support	–	53	





## Programmable Settings

Main menu	Sub-menu 1	Sub-menu 2	Page	
Initial setting 	Talking CallerID	–	55	
	Caller ID edit	–	55	
	Room monitor	–	41	
	LCD contrast	–	56	
	Key tone	–	56	
	Auto talk	–	56	
	Interrupt tone	–	56	
	Set base unit	Ringer volume <sup>*1</sup>		57
		Ringer tone <sup>*1</sup>		58
		Interrupt tone <sup>*1</sup>		58
		Room monitor <sup>*1</sup>		41
		Talking CallerID <sup>*1</sup>		58
	Set tel line	Set dial mode <sup>*1</sup>		19
		Set flash time <sup>*1</sup>		57
		Set line mode <sup>*1</sup>		57
Registration	HS registration		59	
	Deregistration		58	
Change language	–	56		
Set date & time 	Date and time <sup>*1</sup>	–	19	
	Time adjustment <sup>*1</sup>	–	59	

### Color display models: KX-TG5576, KX-TGA551, and KX-TGA552 only

Main menu	Sub-menu 1	Sub-menu 2	Page
Answering device 	Message playback	–	63
	Message alert	–	69
	Ring count <sup>*1</sup>	–	68
	Recording time <sup>*1</sup>	–	69
	Remote code <sup>*1</sup>	–	67
	Call screening <sup>*1</sup>	–	69
Ringer setting 	Ringer volume	–	49
	Ringer tone	–	49
	Customize ring	–	50
	Ring color	–	51

## Programmable Settings

Main menu	Sub-menu 1	Sub-menu 2	Page	
<b>Display setting</b> 	Wallpaper	–	54	
	Appearance	–	55	
	LCD contrast	–	55	
<b>Function</b> 	Voice enhancer	–	52	
	Caller IQ <sup>*2</sup>	View Info.? <sup>*2</sup>	–	
		Get new Info.? <sup>*2</sup>	–	
		Turn CIQ off? <sup>*2</sup>	–	
	Memory status <sup>*3</sup>	–	52	
Customer support	–	53		
<b>Initial setting</b> 	Talking CallerID	–	55	
	Caller ID edit	–	55	
	Room monitor	–	41	
	Key tone	–	56	
	Auto talk	–	56	
	Interrupt tone	–	56	
	Set base unit	Ringer volume <sup>*1</sup>		57
		Ringer tone <sup>*1</sup>		58
		Interrupt tone <sup>*1</sup>		58
		Room monitor <sup>*1</sup>		41
		Talking CallerID <sup>*1</sup>		58
	Set tel line	Set dial mode <sup>*1</sup>		19
		Set flash time <sup>*1</sup>		57
		Set line mode <sup>*1</sup>		57
	Registration	HS registration		59
		Deregistration		58
Change language	–	56		
<b>Set date &amp; time</b> 	Date and time <sup>*1</sup>	–	19	
	Time adjustment <sup>*1</sup>	–	59	

\*1 If you program these settings using one of the handsets, you will not need to program the same item using another handset.

\*2 Caller IQ subscribers only. See the included “Caller IQ” leaflet for more information.

\*3 KX-TGA551 does not support this feature.

### Programming via direct commands

You can also program features using “direct commands”—special codes that take you directly to the feature you wish to program and allow you to select the desired setting. There is no need to scroll through the unit’s menus.

Details of each feature can be found on the corresponding pages.

#### Important:

- Before programming, make sure the handset and base unit are not being used. The handset must be operated near the base unit and while off the base unit or charger.

**1** Press **[MENU]** (center of joystick), then press **[#]**.

Enter direct No.  
:

**2** Enter the desired feature code (shown below).

**3** Enter the desired setting code (shown below).

- This step may vary depending on the feature being programmed.

**4** Press **[SAVE]**.

**5** Press **[OFF]** to exit programming mode.

#### Note:

- If the handset beeps 3 times, you entered an invalid code. Enter the correct code.
- If you make a mistake or enter the wrong code, press **[OFF]** then start again by pressing **[MENU]**.

---

### Direct commands chart

#### Important:

- The default settings are indicated by \*.

Feature	Feature code	Setting code	Page
Date and time	<b>[1] [0] [1]</b>	Enter date and time. (Default: 12.31.2005)	19
Change language	<b>[1] [1] [0]</b>	<b>[1]</b> : English* <b>[2]</b> : Spanish	56
Set dial mode	<b>[1] [2] [0]</b>	<b>[1]</b> : Pulse <b>[2]</b> : Tone*	19
Set flash time	<b>[1] [2] [1]</b>	<b>[1]</b> : 700 ms* <b>[2]</b> : 600 ms <b>[3]</b> : 400 ms <b>[4]</b> : 300 ms <b>[5]</b> : 250 ms <b>[6]</b> : 110 ms <b>[7]</b> : 100 ms <b>[8]</b> : 90 ms	57
Set line mode	<b>[1] [2] [2]</b>	<b>[1]</b> : A <b>[2]</b> : B*	57
HS registration	<b>[1] [3] [0]</b>	Go to step 5 on page 59.	59

## Programmable Settings

Feature	Feature code	Setting code	Page
Deregistration	<b>[1] [3] [1]</b>	<b>[3] [3] [5]</b>	58
LCD contrast (Handset)	<b>[1] [4] [5]</b>	<b>[1]</b> : Level 1 <b>[2]</b> : Level 2 <b>[3]</b> : Level 3* <b>[4]</b> : Level 4 <b>[5]</b> : Level 5 <b>[6]</b> : Level 6	55, 56
Ringer volume (Handset)	<b>[1] [6] [0]</b>	<b>[1]</b> : Low <b>[2]</b> : Medium <b>[3]</b> : High* <b>[0]</b> : Off	49
Ringer tone Tone & Melody (Handset)	<b>[1] [6] [1]</b>	Scroll to "Tone & Melody", then press <b>[SELECT]</b> . <b>[1]</b> : Tone 1* <b>[2]</b> : Tone 2 <b>[3]</b> : Tone 3 <b>[4]</b> : Melody 1 <b>[5]</b> : Melody 2 <b>[6]</b> : Melody 3 <b>[7]</b> : Melody 4	49
Ringer tone Customized ring (Handset)	<b>[1] [6] [1]</b>	Go to step 4 on page 49.	49
Talking Caller ID (Handset)	<b>[1] [6] [2]</b>	<b>[1]</b> : On* <b>[0]</b> : Off	55
Key tone (Handset)	<b>[1] [6] [5]</b>	<b>[1]</b> : On* <b>[0]</b> : Off	56
Customize ring (Handset)	<b>[1] [6] [6]</b>	See page 50.	50
Auto talk	<b>[2] [0] [0]</b>	<b>[1]</b> : On <b>[0]</b> : Off*	56
Interrupt tone (Handset)	<b>[2] [0] [1]</b>	<b>[1]</b> : On <b>[2]</b> : 2 times* <b>[0]</b> : Off	56
Room monitor (Handset)	<b>[2] [0] [2]</b>	<b>[1]</b> : On <b>[0]</b> : Off*	41
Ring count	<b>[2] [1] [1]</b>	<b>[2]</b> : 2 rings <b>[3]</b> : 3 rings <b>[4]</b> : 4 rings* <b>[5]</b> : 5 rings <b>[6]</b> : 6 rings <b>[7]</b> : 7 rings <b>[0]</b> : Toll saver	68
Caller ID number auto edit	<b>[2] [1] [4]</b>	<b>[1]</b> : On* <b>[0]</b> : Off	55
Time adjustment	<b>[2] [2] [6]</b>	<b>[1]</b> : Caller ID[auto]* <b>[2]</b> : Manual	59
Ring color	<b>[2] [3] [5]</b>	<b>[1]</b> : Color 1* <b>[2]</b> : Color 2 <b>[3]</b> : Color 3 <b>[4]</b> : Multicolor	51
Voice enhancer	<b>[2] [7] [0]</b>	<b>[1]</b> : On <b>[0]</b> : Off*	52
Message playback	<b>[3] [0] [0]</b>	–	63
Recording time	<b>[3] [0] [5]</b>	<b>[1]</b> : 1 minute <b>[2]</b> : 2 minutes <b>[3]</b> : 3 minutes* <b>[0]</b> : Greeting only	69

## Programmable Settings

Feature	Feature code	Setting code	Page
Remote code	[3] [0] [6]	Enter remote code. (Default: 11)	67
Call screening	[3] [1] [0]	[1]: On* [0]: Off	69
Message alert	[3] [4] [0]	[1]: On [0]: Off*	69
Customer support	[6] [8] [0]	Confirm URL address.	53
Ringer volume (Base unit)	[*] [1] [6] [0]	[1]: Low [2]: Medium [3]: High* [0]: Off	57
Ringer tone (Base unit)	[*] [1] [6] [1]	[1]: Tone 1* [2]: Tone 2 [3]: Tone 3 [4]: Melody 1 [5]: Melody 2 [6]: Melody 3 [7]: Melody 4	58
Talking Caller ID (Base unit)	[*] [1] [6] [2]	[1]: On* [0]: Off	58
Interrupt tone (Base unit)	[*] [2] [0] [1]	[1]: On [2]: 2 times* [0]: Off	58
Room monitor (Base unit)	[*] [2] [0] [2]	[1]: On [0]: Off*	41

### Direct commands chart (Color display models: KX-TG5576, KX-TGA551, and KX-TGA552 only)

Feature	Feature code	Setting code	Page
Wallpaper	[1] [8] [1]	Go to step 4 on page 54.	54
Appearance	[1] [8] [2]	[1]: Color 1* [2]: Color 2 [3]: Color 3 [4]: Color 4	55
Memory status* <sup>1</sup>	[6] [7] [0]	Confirm memory status.	52

\*1 KX-TGA551 does not support this feature.



## Ringer settings

### Handset ringer volume

4 levels (high/medium/low/off) are available.

- 1** Press **[MENU]** (center of joystick).
- 2** Scroll to , then press **[SELECT]**.
- 3** Scroll to “**Ringer volume**”, then press **[SELECT]**.
- 4** Push the joystick up or down repeatedly to select the desired volume.
  - To turn the ringer off, push the joystick down repeatedly until “**OFF ?**” is displayed.
- 5** Press **[SAVE]**.

#### Note:

- When the ringer volume is set to off, the handset will not ring for outside calls. The handset will ring at the low level for intercom calls.
- When the ringer volume is set to off, the handset will not announce caller names (page 33).

### Handset ringer tone

You can change the ringer tone heard when an outside call is received. There are 3 tones, 4 melodies, and 2 songs.

#### Important:

- You can record songs for the handset ringer tone from an audio device. See “Recording songs from an audio device for ringer tones” on page 50.
- Color display models (KX-TG5576 and KX-TGA552 only):  
You can download songs (in wave file format) for the handset ringer tone from a PC. For information on using this feature, refer to the help section of the GIGARANGE USB Utility software. If you have not installed the GIGARANGE USB Utility software, refer to the included “Installation Guide for GIGARANGE USB Utility” for details.

- 1** Press **[MENU]** (center of joystick).
- 2** Scroll to , then press **[SELECT]**.
- 3** Scroll to “**Ringer tone**”, then press **[SELECT]**.
- 4** To select a tone or melody, scroll to “**Tone & Melody**”, then press **[SELECT]**.  
OR  
To select a song, scroll to “**Customized ring**”, then press **[SELECT]**.
- 5** Push the joystick up or down repeatedly to select the desired item.
  - If the ringer volume has been turned off, the handset will not ring.
- 6** Press **[SAVE]**, then press **[OFF]**.

#### Note:

- If you subscribe to a distinctive ring service (such as IDENT-A-RING), select a tone (Tone 1 to 3). If you select a

## Programmable Settings

melody or a song, you will not be able to distinguish lines by their ringers.

- If you select a melody or a song, the ringer will continue to sound for several seconds if:
  - the caller hangs up before you answer the call.
  - another person answers the call using another phone connected on the same line.
- The preset song “**Demo1**” in this product is used with permission of © 2005 Speed Crazy.
- The preset song “**Demo2**” in this product is used with permission of © 2005 M-ZoNE Co., Ltd.

### Recording songs from an audio device for ringer tones (Customize ring)

You can record songs (max. 30 seconds each) from an audio device by connecting the included audio cable. These songs can be assigned as the handset ringer tone (page 49) and the ringer ID (page 33) for phone numbers stored in the phonebook.

#### Important:

- If a call is received while the audio cable is connected to the handset, disconnect the audio cable from the handset and answer the call, or you and the caller will not hear each other’s voice.
- If a call is received while a song is being recorded or played back, recording or playback will stop automatically. If recording, the partially recorded song will be saved. The caller will hear the song being played and you and the caller will not be able to hear each other’s voice until you disconnect the audio cable from the handset.

- 1 Connect the audio device to the handset using the included audio cable.

Audio device  
(such as a stereo component,  
CD player, or PC)

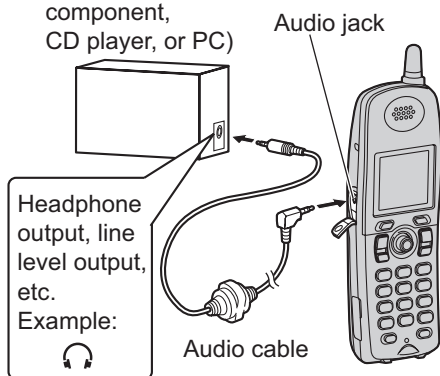

- 2 Press **[MENU]** (center of joystick).
- 3 Scroll to **[Song]**, then press **[SELECT]**.
- 4 Scroll to “**Customize ring**”, then press **[SELECT]**.
- 5 Scroll to “**Record**”, then press **[SELECT]**.
  - The remaining recording time will be displayed.
- 6 Press play on the audio device.
  - For better sound quality, increase the volume on the audio device.
  - To adjust the handset speaker volume, push the joystick up or down repeatedly.
- 7 Press **[REC.]** to start recording.
- 8 To stop recording, press **[STOP]**.
  - To listen to the recording, scroll to “**Playback**”, then press **[SELECT]**.
  - To re-record, scroll to “**Retry**”, press **[SELECT]**, then start from step 7.
- 9 Scroll to “**save**”, then press **[SELECT]**.
- 10 Enter the desired name (max. 15 characters, page 27).

- 11 Press **[SAVE]**, then press **[OFF]**.
- 12 Disconnect the audio cable from the handset.

### Note:

- KX-TG5571, KX-TGA550, and KX-TGA551 only:  
The total recording time is 90 seconds.
- KX-TG5576 and KX-TGA552 only:  
Recorded songs are stored in the same memory storage space as downloaded pictures. If no pictures are stored in the memory, the total recording time is about 7 minutes. Therefore, depending on the data size of the pictures you downloaded, the total recording time will change. To confirm the handset memory for songs and pictures, see page 52.

---

### Playing back a song

- 1 Press **[MENU]** (center of joystick).
- 2 Scroll to , then press **[SELECT]**.
- 3 Scroll to "Customize ring", then press **[SELECT]**.
- 4 Scroll to "Playback", then press **[SELECT]**.
- 5 Push the joystick up or down repeatedly to select the desired song.
- 6 Press **[PLAY]**.
  - The song will be replayed for 1 minute.
- 7 Press **[STOP]**, then press **[OFF]**.

---

### Erasing a song

While the song is selected or playing, press **[ERASE]** or **[CLEAR]**, then press **[YES]**.

### Note:

- If the erased song was used for the handset ringer (page 49), "Tone 1" (default) will be used instead of that song.

- If the erased song was assigned to certain callers (Ringer ID, page 33), the Ringer ID assignment will be canceled, and the handset ringer tone (page 49) will be used instead of that song.

---

### Changing the name of a song

- 1 Press **[MENU]** (center of joystick).
- 2 Scroll to , then press **[SELECT]**.
- 3 Scroll to "Customize ring", then press **[SELECT]**.
- 4 Scroll to "Rename", then press **[SELECT]**.
- 5 Push the joystick up or down repeatedly to select the desired song.
- 6 Press **[RENAME]**.
- 7 Edit the name (max. 15 characters, page 27).
- 8 Press **[SAVE]**, then press **[OFF]**.

---

### Ring color

You can change the ringer indicator color used when an outside call is received. Select "Color1" (amber), "Color2" (blue), "Color3" (green), or "Multicolor".

- 1 Press **[MENU]** (center of joystick).
- 2 Scroll to , then press **[SELECT]**.
- 3 Scroll to "Ring color", then press **[SELECT]**.
- 4 Push the joystick up or down repeatedly to select the desired ringer indicator color.
- 5 Press **[SAVE]**, then press **[OFF]**.

## Programmable Settings

### Function

#### Voice enhancer

You can turn the voice enhancer feature on or off.

- 1 Press **[MENU]** (center of joystick).
- 2 Scroll to , then press **[SELECT]**.
- 3 Scroll to "voice enhancer", then press **[SELECT]**.
- 4 Push the joystick up or down repeatedly to select "on" or "off".
  - When turned on, **VE** will be displayed.
- 5 Press **[SAVE]**, then press **[OFF]**.

#### Memory status (Color display models only)

##### Important:

- Only the KX-TG5576 and KX-TGA552 support this feature.

You can confirm the amount of handset memory used for your pictures, wallpaper patterns, and songs.

A maximum of 126 individual files can be stored in memory (in addition to the preset pictures and songs).

Depending on the size of each file, the number of files which can be stored will decrease.

##### Memory usage

File type	Quantity	Memory used
Wallpaper	1 pattern	1 %
Picture ID	3 patterns	1 %
Song (customized ring)	30 seconds	7 %

- 1 Press **[MENU]** (center of joystick).
- 2 Scroll to , then press **[SELECT]**.
- 3 Scroll to "Memory status", then press **[SELECT]**.

Example: 

Used: 47%
Wallpaper: 10
Picture ID: 6
Custom ring: 5
Total= 21/126

47% of memory used  
10 wallpaper patterns stored  
6 pictures stored  
5 songs stored  
Total 21 files stored

- 4 Press **[OFF]**.

##### Note:

- Data files are retained even if the handset battery is removed or discharged.

---

### Erasing a picture or song

- 1 Follow steps 1 to 3 of “Memory status” on page 52.
- 2 Press **[MENU]** (center of joystick).
- 3 Push the joystick up or down repeatedly to select “1 wallpaper”, “1 picture ID”, or “1 Custom ring”, then press **[SELECT]**.
- 4 Push the joystick up or down repeatedly to select the desired item.
  - To view the name of picture, press **[LIST]**. To return to the picture, press **[VIEW]**.
- 5 Press **[ERASE]**.
  - To cancel erasing, press **[NO]**.
- 6 Press **[YES]**.
  - To continue erasing additional data, repeat from step 4.
- 7 Press **[OFF]**.

---

### Erasing all pictures or songs

- 1 Follow steps 1 to 3 of “Memory status” on page 52.
- 2 Press **[MENU]** (center of joystick).
- 3 Push the joystick up or down repeatedly to select “All wallpapers”, “All picture ID”, or “All Custom ring”, then press **[SELECT]**.
  - To cancel erasing, press **[NO]**.
- 4 Press **[YES]**.
  - To continue erasing additional data, repeat from step 3.
- 5 Press **[OFF]**.

---

### Customer support

The handset can display the Internet address where you can download operating instructions for this product using your computer.

- 1 Press **[MENU]** (center of joystick).
- 2 Scroll to , then press **[SELECT]**.
- 3 Scroll to “Customer support”, then press **[SELECT]**.
  - “[www.panasonic.com/support](http://www.panasonic.com/support)” will be displayed.
- 4 Press **[OFF]**.

### Display setting (Color display models only)

#### Important:

- Only the KX-TG5576, KX-TGA551, and KX-TGA552 support these features.

### Wallpaper

You can select the “wallpaper” pattern shown on the display in standby mode. There are 3 preset patterns.

KX-TG5576 and KX-TGA552 only:

You can also download your original pictures from a PC. Refer to the help section of the GIGARANGE USB Utility software for details. If you have not installed the GIGARANGE USB Utility software, refer to the included “Installation Guide for GIGARANGE USB Utility” for details.

- You cannot download pictures from a PC to the KX-TGA551.

- 1 Press **[MENU]** (center of joystick).
- 2 Scroll to , then press **[SELECT]**.
- 3 Scroll to “**wallpaper**”, then press **[SELECT]**.
- 4 Scroll to “**set picture**”, then press **[SELECT]**.
  - To turn the wallpaper feature off, select “**Turn off**”. The display color will change to the color you selected for color (see “Handset display color” on page 55).
  - For KX-TGA551 users, go to step 6.
- 5 To select a preset pattern, scroll to “**Fixed data**”, then press **[SELECT]**.  
OR  
To select your original picture, scroll to “**User data**”, then press **[SELECT]**.

- 6 Push the joystick up or down repeatedly to select the desired pattern.

- To view the picture name, press **[LIST]**. To return to the picture, press **[VIEW]**.

- 7 Press **[SAVE]**, then press **[OFF]**.

#### Note:

- The preset patterns “**wallpaper1**” and “**wallpaper2**” in this product are used with permission of © 2005 Digital Archive Japan, Inc.
- The preset pattern “**wallpaper3**” in this product is used with permission of © 2005 MIXA Co., Ltd.
- If you have missed calls or new messages, the selected wallpaper pattern will not be displayed while the handset is off the base unit or charger. The display will indicate that you have missed calls or new messages instead.

### Erasing a picture from the “User data”

- 1 Press **[MENU]** (center of joystick).
- 2 Scroll to , then press **[SELECT]**.
- 3 Scroll to “**wallpaper**”, then press **[SELECT]**.
- 4 Scroll to “**set picture**”, then press **[SELECT]**.
- 5 Scroll to “**User data**”, then press **[SELECT]**.
- 6 Push the joystick up or down repeatedly to select the desired picture.
- 7 Press **[CLEAR]**.
  - To cancel erasing, press **[NO]**.
- 8 Press **[YES]**.
  - To erase another picture, repeat from step 6.

### Note:

- If the erased picture was selected for the wallpaper, "Wallpaper1" (default) will be used instead of that picture.

---

### Handset display color (Appearance)

You can select the desired display color.

- 1 Press **[MENU]** (center of joystick).
- 2 Scroll to , then press **[SELECT]**.
- 3 Scroll to "Appearance", then press **[SELECT]**.
- 4 Push the joystick up or down repeatedly to select the desired color.
- 5 Press **[SAVE]**, then press **[OFF]**.

---

### Handset LCD contrast

You can adjust the handset display contrast. There are 6 levels.

- 1 Press **[MENU]** (center of joystick).
- 2 Scroll to , then press **[SELECT]**.
- 3 Scroll to "LCD contrast", then press **[SELECT]**.
- 4 Push the joystick up or down repeatedly to select the desired setting.
- 5 Press **[SAVE]**, then press **[OFF]**.

---

## Initial setting

---

### Handset Talking Caller ID

You can turn the Talking Caller ID feature (page 32) on or off for the handset.

- 1 Press **[MENU]** (center of joystick).
- 2 Scroll to , then press **[SELECT]**.
- 3 Scroll to "Talking CallerID", then press **[SELECT]**.
- 4 Push the joystick up or down repeatedly to select "On" or "Off".
- 5 Press **[SAVE]**, then press **[OFF]**.

---

### Caller ID edit

You can turn the Caller ID number auto edit feature (page 36) on or off.

- 1 Press **[MENU]** (center of joystick).
- 2 Scroll to , then press **[SELECT]**.
- 3 Scroll to "Caller ID edit", then press **[SELECT]**.
- 4 Push the joystick up or down repeatedly to select "On" or "Off".
- 5 Press **[SAVE]**, then press **[OFF]**.

## Programmable Settings

---

### Handset LCD contrast (Monochrome display models only)

#### Important:

- Only the KX-TG5571 and KX-TGA550 support this feature.

You can adjust the handset display contrast. There are 6 levels.

- 1 Press **[MENU]** (center of joystick).
- 2 Scroll to , then press **[SELECT]**.
- 3 Scroll to "LCD contrast", then press **[SELECT]**.
- 4 Push the joystick up or down repeatedly to select the desired setting.
- 5 Press **[SAVE]**, then press **[OFF]**.

---

### Handset key tone

You can select whether or not key tones are heard when keys are pressed. Includes confirmation tones and error tones.

- 1 Press **[MENU]** (center of joystick).
- 2 Scroll to , then press **[SELECT]**.
- 3 Scroll to "Key tone", then press **[SELECT]**.
- 4 Push the joystick up or down repeatedly to select "On" or "Off".
- 5 Press **[SAVE]**, then press **[OFF]**.

---

### Auto talk

When this feature is turned on, you can answer a call by lifting the handset off the base unit or charger without pressing **[↶]**.

- 1 Press **[MENU]** (center of joystick).
- 2 Scroll to , then press **[SELECT]**.

- 3 Scroll to "Auto talk", then press **[SELECT]**.
- 4 Push the joystick up or down repeatedly to select "On" or "Off".
- 5 Press **[SAVE]**, then press **[OFF]**.

#### Note:

- If you subscribe to Caller ID service and want to view the caller's information on the handset display after lifting up the handset to answer a call, turn off this feature.

---

### Handset interrupt tone

This tone lets you know when you receive a call while you are on an intercom call or monitoring a room.

"2": The tone will sound 2 times.

"On": The tone will sound for as long as the line rings.

"Off": Turns this feature off.

- 1 Press **[MENU]** (center of joystick).
- 2 Scroll to , then press **[SELECT]**.
- 3 Scroll to "Interrupt tone", then press **[SELECT]**.
- 4 Push the joystick up or down repeatedly to select the desired setting.
- 5 Press **[SAVE]**, then press **[OFF]**.

---

### Handset display language

You can select either "English" or "Español" as the display language.

- 1 Press **[MENU]** (center of joystick).
- 2 Scroll to , then press **[SELECT]**.
- 3 Scroll to "Change language", then press **[SELECT]**.
- 4 Push the joystick up or down repeatedly to select the desired language.



- 5** Press **[SAVE]** or **[GUARDAR]**, then press **[OFF]**.

**Note:**

- If you select a language you cannot read, press **[MENU]** **[#]** **[1]** **[1]** **[0]** **[1]** **[SAVE]** to change the display language to English.

---

### Flash time

The flash time depends on your telephone exchange or host PBX.

You can select: "90ms" (milliseconds), "100ms", "110ms", "250ms", "300ms", "400ms", "600ms", or "700ms".

- 1** Press **[MENU]** (center of joystick).
- 2** Scroll to , then press **[SELECT]**.
- 3** Scroll to "set tel line", then press **[SELECT]**.
- 4** Scroll to "set flash time", then press **[SELECT]**.
- 5** Push the joystick up or down repeatedly to select the desired setting.
- 6** Press **[SAVE]**, then press **[OFF]**.

**Note:**

- The setting should stay at 700 ms unless pressing the soft key **[FLASH]** fails to pick up the Call Waiting call.
- If the unit is connected via a PBX, certain PBX functions (call transferring, etc.) may not work correctly. Consult your PBX supplier for the correct setting.

---

### Line mode

The line mode is preset to "B" and generally should not be adjusted. If **IN USE** on the handset is not displayed and the IN USE indicator on the base unit does not light properly when another phone connected to the same line is in use, the line mode selection is incorrect. Set line mode to "A".

- 1** Press **[MENU]** (center of joystick).
- 2** Scroll to , then press **[SELECT]**.
- 3** Scroll to "set tel line", then press **[SELECT]**.
- 4** Scroll to "set line mode", then press **[SELECT]**.
- 5** Push the joystick up or down repeatedly to select the desired setting.
- 6** Press **[SAVE]**, then press **[OFF]**.

---

### Base unit settings

These features can be set by using the handset.

---

#### Base unit ringer volume

You can also adjust the base unit ringer volume from the base unit (page 26).

- 1** Press **[MENU]** (center of joystick).
- 2** Scroll to , then press **[SELECT]**.
- 3** Scroll to "set base unit", then press **[SELECT]**.
- 4** Scroll to "Ringer volume", then press **[SELECT]**.
- 5** Push the joystick up or down repeatedly to select the desired volume.
  - To turn the ringer off, push the joystick down repeatedly until "off ?" is displayed.
- 6** Press **[SAVE]**, then press **[OFF]**.

## Programmable Settings

---

### Base unit ringer tone

You can also change the base unit ringer tone from the base unit (page 26).

- 1 Press **[MENU]** (center of joystick).
- 2 Scroll to , then press **[SELECT]**.
- 3 Scroll to "Set base unit", then press **[SELECT]**.
- 4 Scroll to "Ringer tone", then press **[SELECT]**.
- 5 Push the joystick up or down repeatedly to select the desired setting.
  - If the ringer volume has been turned off, the base unit will not ring.
- 6 Press **[SAVE]**, then press **[OFF]**.

### Base unit interrupt tone

This tone lets you know when you receive a call while you are on an intercom call or monitoring a room.

"2": The tone will sound 2 times.

"On": The tone will sound for as long as the line rings.

"Off": Turns this feature off.

- 1 Press **[MENU]** (center of joystick).
- 2 Scroll to , then press **[SELECT]**.
- 3 Scroll to "Set base unit", then press **[SELECT]**.
- 4 Scroll to "Interrupt tone", then press **[SELECT]**.
- 5 Push the joystick up or down repeatedly to select the desired setting.
- 6 Press **[SAVE]**, then press **[OFF]**.

### Base unit Talking Caller ID

You can turn the Talking Caller ID feature (page 32) on or off for the base unit.

- 1 Press **[MENU]** (center of joystick).
- 2 Scroll to , then press **[SELECT]**.
- 3 Scroll to "Set base unit", then press **[SELECT]**.
- 4 Scroll to "Talking CallerID", then press **[SELECT]**.
- 5 Push the joystick up or down repeatedly to select "On" or "Off".
- 6 Press **[SAVE]**, then press **[OFF]**.

---

### Canceling the handset registration

If you no longer need to use the handset or if you want to use the handset with a different base unit of the same model, it is necessary to cancel the handset's registration from the current base unit.

#### Important:

- Before canceling, make sure the base unit is not being used.
- Have the handset and base unit near each other when canceling the handset.

- 1 Press **[MENU]** (center of joystick).
- 2 Scroll to , then press **[SELECT]**.
- 3 Scroll to "Registration", then press **[SELECT]**.
- 4 Scroll to "Deregistration", then press **[SELECT]**.
- 5 Enter **[3] [3] [5]**.
- 6 Press **[OK]**.
  - The handset's extension number (**1** to **8**) will disappear from the display.

- If the handset beeps 3 times, you entered a wrong code. Enter "335", then press **[OK]**.

## Set date & time

### Time adjustment (Caller ID subscribers only)

Using this feature, the unit's date and time setting will be automatically adjusted when caller information is received. To turn this feature on, select "Caller ID[auto]". To turn off, select "Manual".

- 1 Press **[MENU]** (center of joystick).
- 2 Scroll to , then press **[SELECT]**.
- 3 Scroll to "Time adjustment", then press **[SELECT]**.
- 4 Push the joystick up or down repeatedly to select "Manual" or "Caller ID[auto]".
- 5 Press **[SAVE]**, then press **[OFF]**.

#### Note:

- To use this feature, set the date and time manually first (page 19).

## Registering the handset

If you want to use the handset with a different base unit of the same model, register it to that base unit. The handset will be given a new extension number of that base unit.

### Important:

- Before registering, make sure the base unit and the other handsets are not being used.
- Have the handset and base unit near each other when registering the handset.
- If you have already canceled the handset registration at the previous base unit, start from step 5.

#### 1 Handset:

Press **[MENU]** (center of joystick).

2 Scroll to , then press **[SELECT]**.

3 Scroll to "Registration", then press **[SELECT]**.

4 Scroll to "HS registration", then press **[SELECT]**.

#### 5 Base unit:

Press and hold **[INTERCOM]** until the CHARGE indicator flashes.

- After the CHARGE indicator starts flashing, the rest of the procedure must be completed within 1 minute.

#### 6 Handset:

Press **[OK]** (right soft key), then wait until the handset beeps.

- Registration is complete.
- The handset's new extension number (**1** to **8**) will be displayed.

### Answering system

The unit contains an answering system which can answer and record calls for you when you are unavailable to answer the phone.

For details about memory capacity, see page 65.

#### Important:

- Only 1 person can access the answering system (listen to messages, record a greeting message, etc.) at a time.
- When callers leave messages, the unit records the day and time of each message. Make sure the date and time have been set (page 19).
- You can select the caller's recording time (page 69).

### Recording your greeting message

You can record your own greeting message (max. 2 minutes) that will be played when the answering system answers a call. If you do not record a greeting message, a pre-recorded greeting message will be used.

**Sample greeting message:** *"This is (your name). We are unable to answer the phone right now. Please leave a message after the beep. Thank you."*

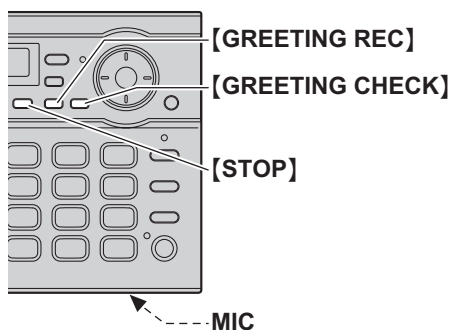

- 1** Press **[GREETING REC]**.
  - The unit announces "To record greeting, press record again."
- 2** Within 10 seconds, press **[GREETING REC]** again.
- 3** After the unit beeps, speak clearly about 20 cm (8 inches) away from the MIC.
  - The display will show the elapsed recording time.
- 4** To stop recording, press **[GREETING REC]** or **[STOP]**.

#### Note:

- If the greeting message is less than 1 second long, the unit beeps 6 times and announces, "Your greeting was not recorded. Record your greeting again."

### To play back the greeting message

Press **[GREETING CHECK]**.

### Erasing your greeting message

Press **[GREETING CHECK]**, and then press **[ERASE]** while your greeting message is playing.

- If you do not re-record your greeting message, the unit will use a pre-recorded greeting message.

### Pre-recorded greeting message

If you do not record a greeting message, one of 2 pre-recorded messages will be played when a call is received depending on the caller's recording time (page 69).

- When the recording time is set to "1min", "2min", or "3min":  
"Hello, we are not available now. Please leave your name and phone number after the beep. We will return your call."
- When the recording time is set to "Greeting only":  
"Hello, we are not available now. Please call again. Thank you for your call."

To play back the pre-recorded greeting, press **[GREETING CHECK]**.

## Turning the answering system on/off

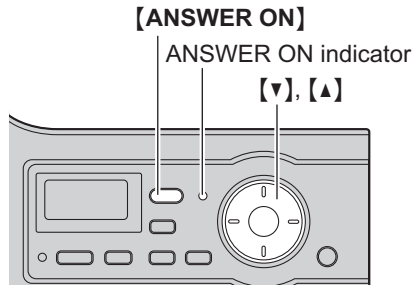

Press **[ANSWER ON]**.

- When the answering system is turned on, the ANSWER ON indicator lights and the unit announces "Answer set" and the day and time.
- When the answering system is turned off, the ANSWER ON indicator turns off and the unit announces "Answer off".

## Screening your calls

While a caller is leaving a message, you can listen to the call through the base unit's speaker. To adjust the speaker volume, press **[▲]** or **[▼]** repeatedly.

You can answer the call by pressing **[SP-PHONE]** on the base unit. To answer the call using the handset, press **[📞]** or **[📞]**.

### Note:

- To turn the speaker volume off while screening a call, decrease the speaker volume to "0" by pressing **[▼]**.
- To turn this feature off, see page 69.

### Listening to messages

When new messages have been recorded:

- The MESSAGE indicator on the base unit will flash.
- The message indicator on the handset will flash slowly if the message alert feature is turned on (page 69).

The base unit display will show the number of messages (old and new) recorded by the answering system.

Example: The total number of recorded messages is 10.

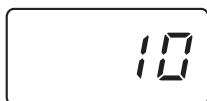

### Listening to messages using the base unit

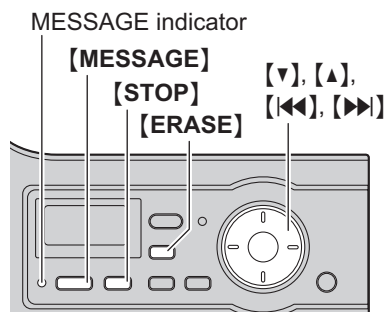

Press **[MESSAGE]**.

- The unit will announce the number of new messages and will play back the new messages.
- When you have no new messages, the unit will announce “*No new messages. All message playback*”, and will play back all messages.

#### Note:

- The display shows the message number during playback.
- During playback, the unit will announce the day and time that each message was recorded. (**Voice time/day stamp**)
- At the end of the last message, the unit announces “*End of final message*”.
- While listening to messages using the handset, the IN USE indicator on the base unit lights.

#### To adjust the speaker volume

9 levels (high to off) are available. Press **[▲]** or **[▼]** repeatedly while using the answering system.

#### Repeating a message

Press **[◀◀]** while listening to the message.

- If pressed within the first 5 seconds of a message, the previous message will be played.

#### Skipping a message

Press **[▶▶]** to play the next message.

#### Pausing message playback

Press **[STOP]**.

- To resume playback, press **[MESSAGE]**.
- To stop playback completely, press **[STOP]** again.

#### Erasing a specific message

Press **[ERASE]** while listening to the message you want to erase.

#### Erasing all messages

- 1 Press **[ERASE]** while the base unit is not being used.
  - The unit will announce “*To erase all messages, press ERASE again.*”
- 2 Within 10 seconds, press **[ERASE]** again.

- The unit will announce “No messages”.

**Note:**

- Caller information for the erased messages will remain in the caller list.

### Listening to messages using the handset

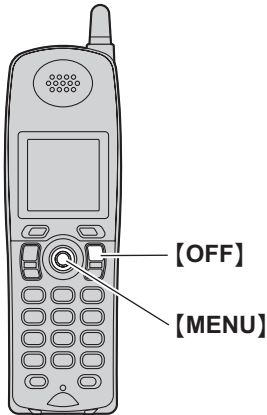

When new messages have been recorded, “New message” is displayed.

- Color display models (KX-TG5576, KX-TGA551, and KX-TGA552 only): If you have both new messages and missed calls and you selected a wallpaper pattern to be shown on the display (page 54), the handset will not display “New message” while it is on the base unit or charger.

**1** Press **[MENU]** (center of joystick).

**2** Press **[PLAY]**.

- The unit will announce the number of new messages, and will play back the new messages.
- To switch to the receiver and to listen to the messages with privacy, press **[📞]**. You can switch back to the speaker by pressing **[🔊]**.
- When you have no new messages, the unit will announce “No new

messages. All message playback”, and will play back all messages.

- After the last message is played back, the unit’s voice guidance starts. Follow the guidance as necessary.

**3** Press **[OFF]** when finished.

**Note:**

- Adjust the speaker or receiver volume by pushing the joystick up or down.
- You can also play back messages as follows:  
Press **[MENU]** (center of joystick), press **[SELECT]** at **[📞]**, then press **[SELECT]** at “Message playback”.
- At the end of the last message, the unit announces “End of final message”.

### Repeating a message

Push the joystick left while listening to the message.

- If pushed within the first 5 seconds of a message, the previous message will be played.

### Skipping a message

Push the joystick right to play the next message.

### Voice guidance

If you do not press any buttons after the last message is played back, the unit’s voice guidance starts. Operate the answering system by following the guidance as necessary.

The unit will announce “Press 4 to play back new messages. Press 5 to play back all messages.”

- You can press buttons for other playback options (page 64) even if the voice guidance has started.
- If you do not press any button within 10 seconds after the voice guidance, the handset returns to standby mode.

## Answering System Features

### Answering system commands

You can also operate the answering system by pressing dial keys.

To use the following commands, press **[MENU]** (center of joystick), then press **[PLAY]**.

Key	Command
<b>[1]</b>	Repeat message (during playback) <sup>*1</sup>
<b>[2]</b>	Skip message (during playback)
<b>[4]</b>	Play new messages
<b>[5]</b>	Play all messages
<b>[8]</b>	Turn answering system on
<b>[9]</b>	Stop playback <sup>*2</sup>
<b>[0]</b>	Turn answering system off
<b>[CLEAR]</b> or <b>[*][4]</b>	Erase this message (during playback)
<b>[*][5]</b>	Erase all messages

\*1 If pressed within the first 5 seconds of a message, the previous message will be played.

\*2 To resume operation, press a command key within 15 seconds, or the voice guidance will start.

### Calling back (Caller ID subscribers only)

If Caller ID information was received for the call, you can call the caller back while listening to a message.

Press **[CALL]** during playback.

#### Note:

- To edit the number before calling back, press **[EDIT]** repeatedly to select the desired format (page 35), then press **[CALL]**, **[↶]**, or **[📞]**.

## Recording a voice memo

You can use the base unit to leave a voice memo (voice message) for yourself or someone else (max. 3 minutes). Voice memos can be played back later with the same operation used to play back answering system messages.

**1** Press **[MEMO]**.

**2** After the unit beeps, speak clearly about 20 cm (8 inches) away from the MIC.

- The display will show the elapsed recording time.

**3** To stop recording, press **[MEMO]** or **[STOP]**.

#### Note:

- Voice memos are treated as new messages.
- If your memo message is less than 1 second long, the unit beeps 6 times and announces, "Your message was not recorded. Record your message again."
- When voice memos are played on the handset, "MEMO" will be displayed.



### Memory capacity

The total recording capacity (including your greeting message, caller messages, and voice memos) is about 21 minutes. A maximum of 64 messages (including a greeting message) can be recorded.

- If message memory becomes full:
  - **FULL** flashes on the base unit.
  - the ANSWER ON indicator flashes rapidly (if the answering system is turned on).
  - the unit announces “*Memory full*” when operating the answering system.

To record additional messages, erase unnecessary messages.

- If less than 3 minutes of recording time is available, the unit will announce the remaining recording time when operating the answering system.
- Messages are retained even if a power failure occurs. All messages are saved until you erase them. (**Flash memory message backup**)
- The total recording capacity may be reduced by the calling party’s background noise.

#### Note:

- If message memory becomes full, the unit will automatically switch to the “**Greeting only**” mode. New messages will not be recorded. If you have recorded your own greeting message, that same greeting message will be announced to callers even though their messages will not be recorded. If you have not recorded your own greeting message, the pre-recorded message used for “**Greeting only**” mode will be announced to callers (page 61).

### Remote operation

Using a touch tone phone, you can call your phone number from outside and access the unit to listen to messages. The unit’s voice guidance will prompt you to press certain dial keys to perform different operations.

#### Important:

- In order to operate the answering system remotely, you must first set a remote code (page 67). This code must be entered each time you operate the answering system remotely.

### Using the answering system remotely

- 1 Dial your phone number from a touch tone phone.
  - If the ring count is set to “**To11 saver**” (page 68), the number of rings you hear will indicate whether or not you have new messages.
- 2 After the greeting message starts, enter your remote code.
  - The unit will announce the number of new messages, and will play back the new messages.
- 3 After 3 seconds, the voice guidance will start. Follow the voice guidance as necessary.
- 4 When finished, hang up.

#### Note:

- When you press a key, press firmly.
- You can hang up at any time.
- You can ignore the voice guidance and control the unit using remote commands.

## Answering System Features

### Voice guidance

During remote operation, the unit's voice guidance will prompt you to press **[1]** to perform a specific operation, or press **[2]** to listen to more available operations. Operations are presented by voice guidance in the following order:

- Play back all messages
- Play back new messages
- Record a message
- Erase all messages
- Record your greeting message

#### Note:

- If you do not press any dial keys within 10 seconds after a voice guidance prompt, the unit will announce, "Thank you for your call" then disconnect your call.
- If less than 3 minutes of recording time is available, the unit will announce the remaining recording time after the last message is played back.
- If the unit announces "Memory full", erase unnecessary messages.

### Remote commands

You can press dial keys to access certain answering system functions without waiting for the voice guidance to prompt you.

Key	Remote command
<b>[1]</b>	Repeat message (during playback) <sup>*1</sup>
<b>[2]</b>	Skip message (during playback)
<b>[4]</b>	Play new messages
<b>[5]</b>	Play all messages
<b>[7]</b>	Record a greeting message
<b>[9]</b>	Stop (recording, playback) <sup>*2</sup>
<b>[0]</b>	Turn answering system off
<b>[*][4]</b>	Erase this message (during playback)
<b>[*][5]</b>	Erase all messages

\*1 If pushed within the first 5 seconds of a message, the previous message will be played.

\*2 To resume operation, enter a remote command within 15 seconds, or the voice guidance will start.

### Turning on the answering system remotely

If the answering system is off, you can turn it on remotely.

- 1** Dial your phone number.
- 2** Let the phone ring 15 times.
  - The unit will answer your call with the greeting message.
  - You can hang up, or if you call from a touch tone phone, you can enter your remote code and begin remote operation (page 65).

### Skipping the greeting message to leave a message

You can leave a message just as any outside caller can. Call your phone number, then press **[\*]** to skip the greeting message and record your message after the beep.

## Answering system settings

### Remote code

A remote code must be entered when operating the answering system remotely. This code prevents unauthorized parties from listening to your messages remotely. Store any 2-digit number (00–99).

- 1 Press **[MENU]** (center of joystick).
- 2 Scroll to , then press **[SELECT]**.
- 3 Scroll to “Remote code”, then press **[SELECT]**.
- 4 Select the desired remote code by entering a 2-digit number (00–99).
- 5 Press **[SAVE]**, then press **[OFF]**.

#### Note:

- To confirm the remote code, repeat steps 1 to 3. Press **[OFF]** when finished.

## Answering System Features

---

### Ring count

You can change the number of times the phone rings before the unit answers calls. You can select 2 to 7 rings or “**To11 saver**”.

“**To11 saver**”: The unit answers on the 2nd ring when new messages have been recorded, and on the 4th ring when there are no new messages. If you call your phone from outside to listen to new messages (page 65), you will know that there are no messages when the phone rings for the 3rd time. You can then hang up without being charged for the call.

- 1 Press **[MENU]** (center of joystick).
- 2 Scroll to , then press **[SELECT]**.
- 3 Scroll to “**Ring count**”, then press **[SELECT]**.
- 4 Push the joystick up or down repeatedly to select the desired setting.
- 5 Press **[SAVE]**, then press **[OFF]**.

#### Note:

- Usually the unit will announce the caller’s name after the 2nd ring. If you turn on the answering system, and set the ring count to 2 rings, the unit will not announce the caller’s name. If “**To11 saver**” is selected, and there is a new message, the unit will not announce the caller’s name.

---

### For Voice Mail service subscribers

If you subscribe to a flat-rate bundle service that includes Caller ID, Call Waiting, Voice Mail, and unlimited local/regional/long distance calls, please note the following:

- To use the Voice Mail service provided by the telephone company rather than the unit’s answering system, turn off the answering system (page 61).

This unit does not have an indicator to indicate if there are new messages in your mailbox service.

- To use this unit’s answering system rather than the Voice Mail service provided by your telephone company, please contact your telephone company to deactivate your Voice Mail service. If the telephone company cannot do this:
  - Set this unit’s “**Ring count**” setting so that this unit’s answering system answers calls before the telephone company’s Voice Mail service tries to answer your calls. It is necessary to check the ring count required to activate the Voice Mail service provided by your telephone company before changing this setting.
  - Change the ring count of the Voice Mail service so that the answering system can answer the call first. To do so, consult your telephone company.

### Caller's recording time

You can change the maximum message recording time allotted to each caller.

**"1min", "2min", or "3min"**: Caller messages are limited to 1 minute to 3 minutes.

**"Greeting only"**: The unit plays the greeting message but does not record caller messages.

- 1 Press **[MENU]** (center of joystick).
- 2 Scroll to , then press **[SELECT]**.
- 3 Scroll to **"Recording time"** then press **[SELECT]**.
- 4 Push the joystick up or down repeatedly to select the desired setting.
- 5 Press **[SAVE]**, then press **[OFF]**.

### Message alert

You can select whether or not the message indicator on the handset will flash when new messages have been recorded (page 62).

- 1 Press **[MENU]** (center of joystick).
- 2 Scroll to , then press **[SELECT]**.
- 3 Scroll to **"Message alert"**, then press **[SELECT]**.
- 4 Push the joystick up or down repeatedly to select **"On"** or **"Off"**.
- 5 Press **[SAVE]**, then press **[OFF]**.

#### Note:

- The message indicator will not flash for new messages while the handset is in use.
- While message alert is on, battery operating time will be shortened (page 13).

### Turning call screening on/off

While a caller is leaving a message, you can screen the call through the base unit speaker.

- 1 Press **[MENU]** (center of joystick).
- 2 Scroll to , then press **[SELECT]**.
- 3 Scroll to **"Call screening"**, then press **[SELECT]**.
- 4 Push the joystick up or down repeatedly to select **"On"** or **"Off"**.
- 5 Press **[SAVE]**, then press **[OFF]**.

## Wall mounting

The base unit can be mounted on a wall phone plate.

- 1 Connect the AC adaptor.

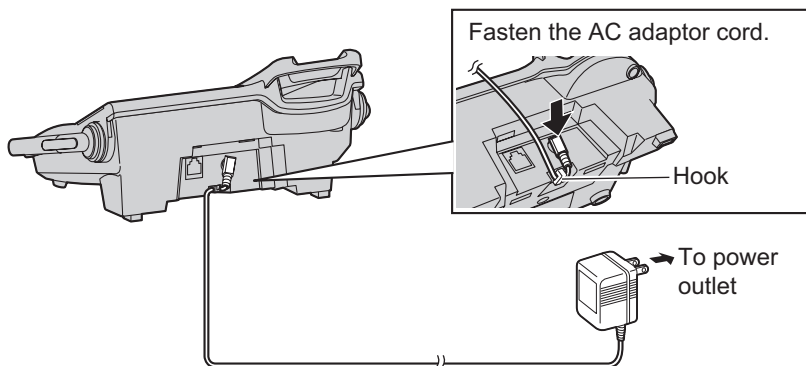

- 2 Tuck the telephone line cord inside the wall mounting adaptor (①).  
Connect the telephone line cord (②).

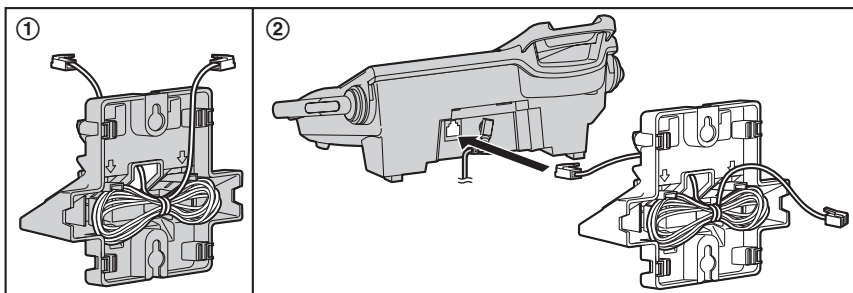

- 3 Insert the hooks on the wall mounting adaptor into the holes (A) and (B) on the base unit.

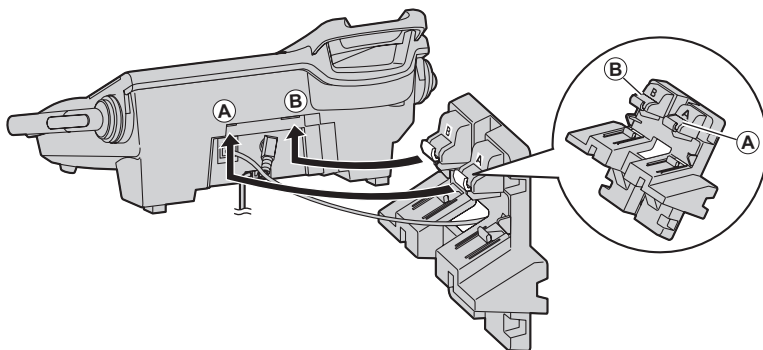

- 4** Adjust the adaptor to hold the base unit, then push it in the direction of the arrow until it clicks into place.

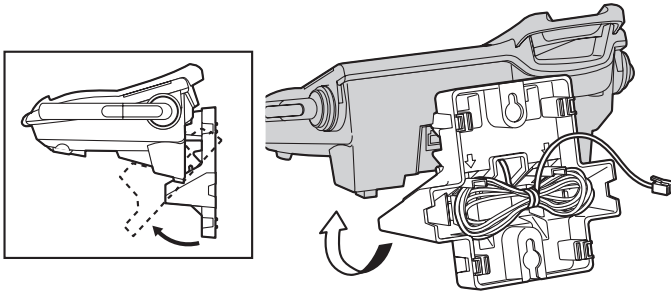

- 5** Connect the telephone line cord. Mount the unit by inserting the mounting pins (A) and (B) into the round openings on the adaptor, then sliding the unit down to secure the unit.

- The position of the mounting pins may vary depending on the size of the wall mounting plate installed. Refer to the illustration below.
- Raise the antennas.

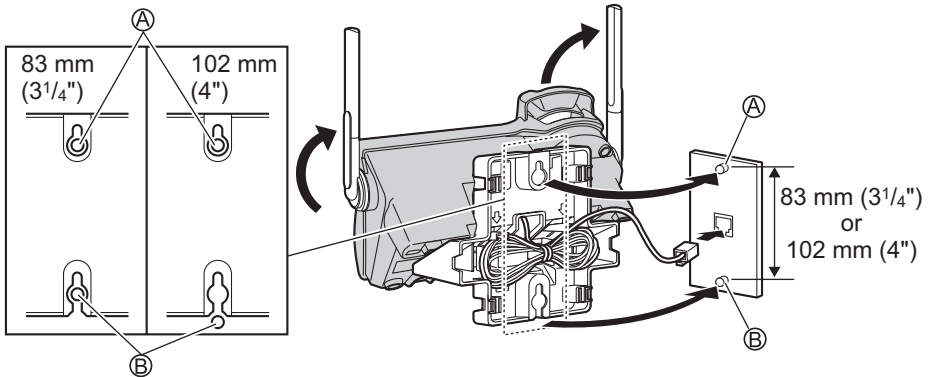

## Useful Information

---

### To remove the wall mounting adaptor

While pushing down the release levers (①), remove the adaptor (②).

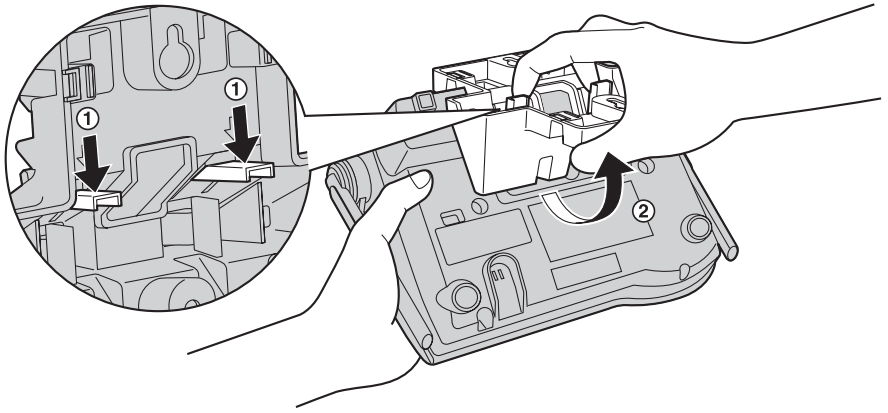



## Belt clip

You can hang the handset on your belt or pocket using the included belt clip.

### To attach the belt clip

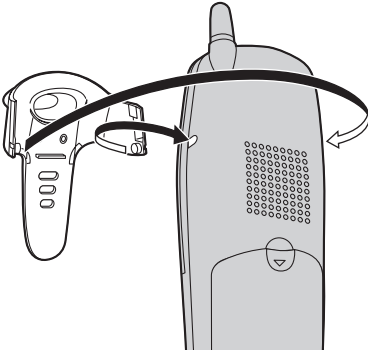

### To remove the belt clip

While pressing the top of the clip (①), pull the right edge in the direction of the arrow (②).

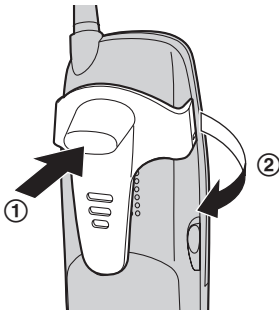

## Headset (optional)

Connecting an optional headset to the handset allows hands-free phone conversations. Please use only a Panasonic headset. See page 6 for compatible headsets and ordering information.

### To connect an optional headset to the handset

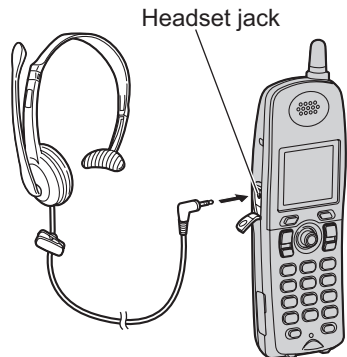
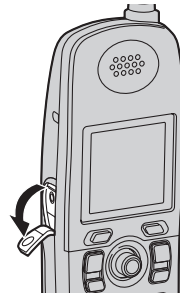

- Model shown is KX-TCA86.



#### Note:

- To switch to the speakerphone, press . To return to the headset, press .

### Error messages

If the unit detects a problem, one of the following messages will be displayed on the handset.

Display message	Cause & solution
<b>Busy</b>	<ul style="list-style-type: none"> <li>● The called handset or base unit is in use.</li> <li>● Privacy mode is on for the call you tried to join (page 22).</li> <li>● The handset you tried to copy phonebook items to is in use.</li> <li>● The handset you are calling is too far from the base unit.</li> </ul>
<b>Denied</b>	<ul style="list-style-type: none"> <li>● The room monitor feature is turned off on the destination handset or base unit and the room cannot be monitored (page 41).</li> <li>● The called handset is on the base unit. The handset must be off the base unit to be monitored.</li> </ul>
<b>Error!!</b>	<ul style="list-style-type: none"> <li>● When you tried to register or deregister the handset, the handset and the base unit could not link for some reason, such as interference from electrical appliances. Move the handset and the base unit away from the electrical appliances and try again.</li> <li>● If more than one handset is in use, you may not be able to register/deregister. Try again later.</li> <li>● Another handset tried to send phonebook items to you but there was an error. Have the other handset user re-send the items to you (page 30).</li> </ul>
<b>Error!! All handsets registered. Maximum is 8.</b>	<ul style="list-style-type: none"> <li>● 8 handsets have already been registered to the base unit. To cancel a handset's registration, see page 58.</li> <li>● You may have registered one of your handsets to another base unit without deleting its registration to this base unit. Erase the handset's registration from the base unit. Base unit: (1) Press and hold <b>[INTERCOM]</b> until the CHARGE indicator flashes, and (2) Press and hold the handset's extension number <b>[1]</b> to <b>[8]</b> that you do not want for 5 seconds. A long beep sounds, then the handset number is erased.</li> </ul>
<b>---Incomplete--- Tom Jones 555-765-4321 Phonebook full (The name/number is an example.)</b>	<ul style="list-style-type: none"> <li>● When phonebook items were sent to another handset, the handset's phonebook memory was full and copying stopped. Press <b>[OFF]</b> to exit. Erase items from another handset's phonebook (page 29). When phonebook memory is available, you can copy all phonebook items (page 30) or individual items one by one (page 30).</li> </ul>

Display message	Cause & solution
<p>---Incomplete---</p> <p>Tom Jones</p> <p>555-765-4321</p> <p>(The name/number is an example.)</p>	<ul style="list-style-type: none"> <li>● The destination handset is out of area.</li> <li>● The destination handset user may have pressed [] or [].</li> </ul>
Invalid	<ul style="list-style-type: none"> <li>● There is no handset registered to the base unit matching the extension number you entered.</li> <li>● You selected your own extension number.</li> <li>● You cannot rename the preset song.</li> </ul>
Invalid. Please register to the base unit	<ul style="list-style-type: none"> <li>● The handset you tried to call has not been registered to the base unit. Register the handset (page 59).</li> </ul>
Memory full	<ul style="list-style-type: none"> <li>● There is no space in memory to record new songs. Erase unnecessary songs.</li> </ul>
No items stored	<ul style="list-style-type: none"> <li>● Your phonebook or redial list is empty.</li> <li>● Color display models (KX-TG5576 and KX-TGA552 only): "User data" is empty. You can download your original data for the wallpaper and picture ID from a PC. Refer to the help section of the GIGARANGE USB Utility software for details.</li> </ul>
No link to base. Move closer to base, try again.	<ul style="list-style-type: none"> <li>● The handset has lost communication with the base unit. Move closer to the base unit, and try again.</li> <li>● Confirm that the base unit's AC adaptor is plugged in.</li> <li>● Raise the base unit antennas.</li> <li>● The handset's registration may have been canceled. Re-register the handset (page 59).</li> </ul>
Not erasable	<ul style="list-style-type: none"> <li>● You cannot erase the preset song.</li> </ul>
Phonebook full	<ul style="list-style-type: none"> <li>● There is no space to store new items in the phonebook. Erase unnecessary items (page 29).</li> </ul>
Please lift up and try again.	<ul style="list-style-type: none"> <li>● A handset button was pressed while the handset was on the base unit or charger. Lift the handset and press the button again.</li> </ul>
System is busy. Please try again later.	<ul style="list-style-type: none"> <li>● The handset has lost communication with the base unit. Move closer to the base unit, and try again.</li> <li>● Other units are in use and the system is busy. Try again later.</li> <li>● Another user is listening to messages. Try again later.</li> </ul>

# Troubleshooting

---

### General use

---

Problem	Cause & solution
The unit does not work.	<ul style="list-style-type: none"><li>● Make sure that the battery is installed correctly (page 12).</li><li>● Check the connections (page 11).</li><li>● Fully charge the battery (page 13).</li><li>● Clean the charge contacts and charge again (page 13).</li><li>● Unplug the base unit's AC adaptor to reset the unit. Reconnect the adaptor and try again.</li><li>● The handset has not been registered to the base unit. Register the handset (page 59).</li><li>● Re-install the battery (page 12) and fully charge it.</li></ul>
The display shows "No link to base. Move closer to base, try again." and an alarm tone sounds.	<ul style="list-style-type: none"><li>● The handset has lost communication with the base unit. Move closer to the base unit, and try again.</li><li>● Confirm that the base unit's AC adaptor is plugged in.</li><li>● Raise the base unit antennas.</li><li>● The handset's registration may have been canceled. Re-register the handset (page 59).</li></ul>
I cannot hear a dial tone.	<ul style="list-style-type: none"><li>● Confirm that the telephone line cord is connected (page 11).</li><li>● Disconnect the unit from the telephone line and connect a known working telephone. If the working telephone operates properly, contact our service personnel to have the unit repaired. If the working telephone does not operate properly, contact your telephone company.</li></ul>
The handset displays the incorrect time.	<ul style="list-style-type: none"><li>● The handset has lost communication with the base unit (because the base unit's AC adaptor is not connected or the handset is out of range). Confirm that the base unit's AC adaptor is connected and move the handset closer to the base unit.</li></ul>

### Programmable settings

---

Problem	Cause & solution
I cannot program items.	<ul style="list-style-type: none"><li>● Programming is not possible while the handset and base unit are being used.</li><li>● Do not pause for over 1 minute while programming.</li><li>● Move closer to the base unit.</li><li>● While another user is listening to messages or the answering system is answering a call, you cannot program. Try again later.</li></ul>

Problem	Cause & solution
While programming, the handset starts to ring.	<ul style="list-style-type: none"> <li>● A call is being received. Answer the call and start again from the beginning after hanging up.</li> </ul>
I cannot record, download, or erase songs, and “Recharge battery” is displayed. I cannot download or erase pictures, and “Recharge battery” is displayed.	<ul style="list-style-type: none"> <li>● The battery power is low. Fully charge the battery (page 13) and try again.</li> </ul>

### Making/answering calls, Intercom

Problem	Cause & solution
Static is heard, sound cuts in and out. Interference from other electrical units.	<ul style="list-style-type: none"> <li>● Move the handset and the base unit away from other electrical appliances.</li> <li>● Move closer to the base unit.</li> <li>● Raise the base unit antennas.</li> <li>● Turn on the clarity booster feature (page 22).</li> <li>● If your unit is connected to a telephone line with DSL service, we recommend connecting a noise filter between the base unit and the telephone line jack. Contact your DSL provider for details.</li> </ul>
The handset and base unit do not ring.	<ul style="list-style-type: none"> <li>● The ringer volume is turned off. Adjust it (page 26, 49).</li> </ul>
I cannot make a call.	<ul style="list-style-type: none"> <li>● The dialing mode may be set incorrectly. Set the dial mode (page 19) to match the type of telephone service you have (tone or pulse).</li> <li>● If the base unit (including answering system) or another handset is in use, you may not be able to make a call. Try again later.</li> <li>● While listening to messages using the handset, you cannot make a call. Exit by pressing <b>[OFF]</b>.</li> </ul>
I cannot redial by pressing <b>[REDIAL]</b> .	<ul style="list-style-type: none"> <li>● If the last number dialed was more than 48 digits long, the number will not be redialed correctly.</li> <li>● If you press <b>[REDIAL]</b> after you have started dialing, this button functions as the <b>[PAUSE]</b> button. To redial, do not dial any numbers before pressing <b>[REDIAL]</b>.</li> </ul>
I cannot have a conversation using the headset.	<ul style="list-style-type: none"> <li>● Make sure that an optional headset is connected properly (page 73).</li> <li>● If “<b>SP-phone</b>” is displayed on the handset, press <b>[</b> to switch to the headset.</li> </ul>
I cannot make long distance calls.	<ul style="list-style-type: none"> <li>● Make sure that you have long distance service.</li> </ul>

## Useful Information

Problem	Cause & solution
I cannot page the handset or base unit.	<ul style="list-style-type: none"><li>● The called handset is too far from the base unit.</li><li>● The called unit is in use. Try again later.</li></ul>
I cannot make a voice announcement.	<ul style="list-style-type: none"><li>● Other handsets are in use. Try again later.</li></ul>
I cannot turn the clarity booster feature on.	<ul style="list-style-type: none"><li>● Another handset is already using this feature. Only one handset can use this feature.</li><li>● If 3 handsets are on a conference call with an outside party, this feature cannot be used by any of the handsets.</li></ul>

## Phonebook

Problem	Cause & solution
I cannot store an item in the phonebook.	<ul style="list-style-type: none"><li>● You cannot store an item in the phonebook while the handset is in talk, speakerphone or intercom mode, or while listening to messages.</li><li>● Do not pause for over 1 minute while storing.</li></ul>
While storing an item in the phonebook, the handset starts to ring.	<ul style="list-style-type: none"><li>● A call is being received. Answer the call and start again from the beginning after hanging up.</li></ul>
Copying stopped with an item displayed.	<ul style="list-style-type: none"><li>● The destination handset may have lost communication with the base unit, or the destination handset user may have pressed <b>[↶]</b> or <b>[↷]</b>. The displayed phonebook item was not copied to the handset. Press <b>[OFF]</b>. Confirm that the destination handset is in standby mode (i.e., not in use) and try again.</li></ul>
The display exits the phonebook while searching.	<ul style="list-style-type: none"><li>● The handset automatically exits after 1 minute of inactivity.</li></ul>

## Caller ID

Problem	Cause & solution
The handset does not display the caller's name and/or phone number.	<ul style="list-style-type: none"> <li>● You have not subscribed to Caller ID service. Contact your telephone company to subscribe.</li> <li>● If your unit is connected to any additional telephone equipment such as a Caller ID box or wireless telephone jack, disconnect the unit from the equipment and plug the unit directly into the wall jack.</li> <li>● If your unit is connected to a telephone line with DSL service, we recommend connecting a noise filter between the base unit and the telephone line jack. Contact your DSL provider for details.</li> <li>● The name display service may not be available in some areas. Contact your telephone company for details.</li> <li>● Other telephone equipment may be interfering with this unit. Disconnect the other equipment and try again.</li> <li>● The caller requested not to send caller information (page 32).</li> <li>● If a call is being transferred to you, the caller information will not be displayed.</li> <li>● Generally caller information is displayed from the 2nd ring.</li> </ul>
The handset or base unit does not announce the displayed caller names.	<ul style="list-style-type: none"> <li>● The handset or base unit's ringer volume is turned off. Adjust it (page 26, 49).</li> <li>● The Talking Caller ID feature is turned off. Turn it on (page 55, 58).</li> <li>● Caller names will usually be announced after the 2nd ring.</li> <li>● The ring count for the answering system is set to "2" or "To11 saver". Select a different setting (page 68).</li> </ul>
The handset or base unit does not announce the displayed caller's name correctly.	<ul style="list-style-type: none"> <li>● Name pronunciation may vary. This feature may not pronounce all names correctly.</li> <li>● The handset or base unit will announce each letter of abbreviations, such as "Co." and "Inc."</li> <li>● Caller ID supports a name of up to 15 letters. If the caller's name has more than 15 letters, the name will not be announced correctly.</li> </ul>
The caller list/incoming phone numbers are not edited automatically.	<ul style="list-style-type: none"> <li>● The Caller ID number auto edit feature is turned off. Turn it on and try again (page 55).</li> <li>● You need to call back the edited number to activate Caller ID number auto edit.</li> </ul>
I cannot dial the phone number edited in the caller list.	<ul style="list-style-type: none"> <li>● The phone number you dialed might have an incorrect edited pattern (for example, the long distance "1" or the area code is missing). Edit the phone number with another pattern (page 35).</li> </ul>

## Useful Information

Problem	Cause & solution
The display exits the caller list while searching.	<ul style="list-style-type: none"> <li>● The handset automatically exits after 1 minute of inactivity.</li> </ul>
The 2nd caller's information is not displayed during an outside call. (The Call Waiting Caller ID (CWID) feature does not function.)	<ul style="list-style-type: none"> <li>● In order to use Caller ID, Call Waiting, or Call Waiting Caller ID (CWID), you must first contact your telephone company and subscribe to the desired service. After subscribing, you may need to contact your telephone company again to activate this specific service, even if you already subscribed to both Caller ID and Call Waiting with Caller ID services (CWID).</li> </ul>
The handset display does not indicate that you have new messages or missed calls, even though you do.	<ul style="list-style-type: none"> <li>● If the wallpaper feature is turned on, the wallpaper pattern is displayed when you press <b>[OFF]</b> 2 times. To display "New message" or the number of missed calls again, press <b>[MENU]</b> then <b>[OFF]</b>.</li> </ul>





## Answering system

Problem	Cause & solution
I cannot listen to messages from a remote location.	<ul style="list-style-type: none"> <li>● A touch tone phone is required for remote operation.</li> <li>● Press the remote code correctly and press each key firmly (page 65).</li> <li>● The answering system is off. Turn it on (page 66).</li> </ul>
<b>FULL</b> flashes and the ANSWER ON indicator flashes rapidly. No new messages are recorded.	<ul style="list-style-type: none"> <li>● Message memory is full. Erase unnecessary messages (page 62).</li> </ul>
The unit does not record new messages.	<ul style="list-style-type: none"> <li>● The answering system is turned off. Turn it on (page 61, 66).</li> <li>● The recording time is set to "Greeting only". Select "1min", "2min", or "3min" (page 69).</li> <li>● Message memory is full. Erase unnecessary messages (page 62).</li> <li>● If you subscribe to the Voice Mail service, messages are recorded by the telephone company not your telephone. Change the unit's "Ring count" setting so that the unit's answering system can answer the call before the Voice Mail service or consult your telephone company (page 68).</li> </ul>
I cannot operate the answering system.	<ul style="list-style-type: none"> <li>● Someone is operating the answering system.</li> <li>● If someone is talking on a conference call, you cannot operate the answering system. Try again later.</li> </ul>
During message playback, the unit rings and cancels playback.	<ul style="list-style-type: none"> <li>● A call is being received. Answer the call and start again from the beginning after hanging up.</li> </ul>



Problem	Cause & solution
The message indicator on the handset flashes slowly.	<ul style="list-style-type: none"> <li>● New messages have been recorded. Listen to the new messages (page 62) or turn the message alert off (page 69).</li> </ul>
When you play back messages or turn on the answering system, the base unit and handset announce the day and time incorrectly.	<ul style="list-style-type: none"> <li>● Set the date and time again (page 19).</li> </ul>

### Battery recharge

Problem	Cause & solution
“Recharge battery” is displayed,  flashes or the handset beeps intermittently.	<ul style="list-style-type: none"> <li>● Fully charge the battery (page 13).</li> </ul>
“Charge for 6 HRS” and  are displayed and the handset does not work.	<ul style="list-style-type: none"> <li>● The battery has been discharged. Fully charge the battery (page 13).</li> </ul>
I charged the battery fully, but “Recharge battery” is still displayed and/or  continues to flash, or “Charge for 6 HRS” and  are displayed.	<ul style="list-style-type: none"> <li>● Clean the charge contacts and charge again (page 13).</li> <li>● The battery may need to be replaced (page 14). If you install a new battery, fully charge it (page 13).</li> </ul>
The CHARGE indicator does not go out after the battery has been charged.	<ul style="list-style-type: none"> <li>● This is normal.</li> </ul>
The handset display is blank.	<ul style="list-style-type: none"> <li>● Confirm that the battery is properly installed.</li> <li>● Fully charge the battery (page 13).</li> </ul>

## ***Useful Information***

---

### **Power failure**

---

<b>Problem</b>	<b>Cause &amp; solution</b>
The unit will not function.	<ul style="list-style-type: none"><li>• This product is not designed to make calls in the event of a power failure. We recommend connecting a standard telephone to the same telephone line in the event that emergency calls need to be made during a power failure (page 11).</li></ul>

## FCC and other information

This equipment complies with Part 68 of the FCC rules and the requirements adopted by the ACTA. On the bottom of this equipment is a label that contains, among other information, a product identifier in the format US:ACJ----- . If requested, this number must be provided to the telephone company.

- Registration No  
.....(found on the bottom of the unit)
- Ringer Equivalence No.  
(REN).....0.1B

A plug and jack used to connect this equipment to the premises wiring and telephone network must comply with the applicable FCC Part 68 rules and requirements adopted by the ACTA. A compliant telephone cord and modular plug is provided with this product. It is designed to be connected to a compatible modular jack that is also compliant.

The REN is used to determine the number of devices that may be connected to a telephone line. Excessive RENs on a telephone line may result in the devices not ringing in response to an incoming call. In most but not all areas, the sum of RENs should not exceed five (5.0). To be certain of the number of devices that may be connected to a line, as determined by the total RENs, contact the local telephone company. For products approved after July 23, 2001, the REN for this product is part of the product identifier that has the format US:AAAEQ##TXXXX. The digits represented by ## are the REN without a decimal point (e.g., 03 is a REN of 0.3).

If this equipment causes harm to the telephone network, the telephone company will notify you in advance that temporary discontinuance of service may be required. But if advance notice isn't practical, the telephone company will

notify the customer as soon as possible. Also, you will be advised of your right to file a complaint with the FCC if you believe it is necessary.

The telephone company may make changes in its facilities, equipment, operations or procedures that could affect the operation of the equipment. If this happens the telephone company will provide advance notice in order for you to make necessary modifications to maintain uninterrupted service.

If trouble is experienced with this equipment, for repair or warranty information, please contact a Factory Servicenter or other Authorized Servicer. If the equipment is causing harm to the telephone network, the telephone company may request that you disconnect the equipment until the problem is resolved.

Connection to party line service is subject to state tariffs. Contact the state public utility commission, public service commission or corporation commission for information.

If your home has specially wired alarm equipment connected to the telephone line, ensure the installation of this equipment does not disable your alarm equipment. If you have questions about what will disable alarm equipment, consult your telephone company or a qualified installer.

This equipment is hearing aid compatible as defined by the FCC in 47 CFR Section 68.316.

## Useful Information

---

When you hold the phone to your ear, noise might be heard in your Hearing Aid. Some Hearing Aids are not adequately shielded from external RF (radio frequency) energy. If noise occurs, use an optional headset accessory or the speakerphone option (if applicable) when using this phone. Consult with your audiologist or Hearing Aid manufacturer about the availability of Hearing Aids which provide adequate shielding to RF energy commonly emitted by digital devices.

### WHEN PROGRAMMING EMERGENCY NUMBERS AND(OR) MAKING TEST CALLS TO EMERGENCY NUMBERS:

- 1) Remain on the line and briefly explain to the dispatcher the reason for the call.
- 2) Perform such activities in the off-peak hours, such as early morning or late evenings.

The software contained in this equipment to allow user access to the network must be upgraded to recognize newly established network area codes and exchange codes as they are placed into service.

Failure to upgrade the premises systems or peripheral equipment to recognize the new codes as they are established will restrict the customer and the customer's employees from gaining access to the network and to these codes.

This device complies with Part 15 of the FCC Rules. Operation is subject to the following two conditions:

(1) This device may not cause harmful interference, and (2) this device must accept any interference received, including interference that may cause undesired operation.

Privacy of communications may not be ensured when using this phone.

### CAUTION:

Any changes or modifications not expressly approved by the party responsible for compliance could void the user's authority to operate this device.

### NOTE:

This equipment has been tested and found to comply with the limits for a Class B digital device, pursuant to Part 15 of the FCC Rules. These limits are designed to provide reasonable protection against harmful interference in a residential installation. This equipment generates, uses, and can radiate radio frequency energy and, if not installed and used in accordance with the instructions, may cause harmful interference to radio communications. However, there is no guarantee that interference will not occur in a particular installation. If this equipment does cause harmful interference to radio or television reception, which can be determined by turning the equipment off and on, the user is encouraged to try to correct the interference by one or more of the following measures:

- Reorient or relocate the receiving antenna.
- Increase the separation between the equipment and receiver.
- Connect the equipment into an outlet on a circuit different from that to which the receiver is connected.
- Consult the dealer or an experienced radio/TV technician for help.

Some cordless telephones operate at frequencies that may cause interference to nearby TVs and VCRs. To minimize or prevent such interference, the base of the cordless telephone should not be placed near or on top of a TV or VCR. If interference is experienced, move the cordless telephone further away from the TV or VCR. This will often reduce, or eliminate, interference.

### **FCC RF Exposure Warning:**

This product complies with FCC radiation exposure limits set forth for an uncontrolled environment. To comply with FCC RF exposure requirements the base unit must be installed and operated with its antenna located 20 cm or more between antenna and all person's body (excluding extremities of hands, wrist and feet). The handset unit may be carried and operated with only the specific provided belt-clip. Other non-tested belt-clips or similar body-worn accessories may not comply and must be avoided. The base and handset units must not be co-located or operated in conjunction with any other antenna or transmitter.

### **Responsible party:**

Panasonic Corporation of North America  
One Panasonic Way,  
Secaucus, New Jersey 07094  
Phone number: 1-800-211-PANA (7262)

### **FCC Warning (KX-TG5576 and KX-TGA552 only):**

To ensure compliance with FCC emissions limits, use only the included USB cable with the ferrite core when connecting the unit to a computer.

## **openLCR service for the Caller IQ feature**

This unit is compatible with service provided by openLCR.

### **Important:**

See the leaflet included with this unit for more information.

- **If you have any questions regarding the openLCR service, visit [www.openLCR.com](http://www.openLCR.com) or call openLCR at 1-866-openLCR (1-866-673-6527).**
- **NEITHER PANASONIC COMMUNICATIONS CO., LTD. NOR PANASONIC CORPORATION OF NORTH AMERICA IS IN ANY WAY AFFILIATED WITH, OR RESPONSIBLE FOR THE ACTS OR OMISSIONS OF, OPENLCR.COM, INC. NEITHER PANASONIC COMMUNICATIONS CO., LTD. NOR PANASONIC CORPORATION OF NORTH AMERICA NOR ANY OF THEIR EMPLOYEES OR AFFILIATES OR CUSTOMERS MAKE ANY WARRANTIES OR REPRESENTATIONS, EITHER EXPRESS OR IMPLIED, TO ANY CUSTOMER OR ANY OTHER THIRD PARTY WITH RESPECT TO ANY OF THE SERVICES PROVIDED BY OPENLCR.COM, INC., NOR ASSUME NOR CREATE ANY OTHER OBLIGATION OF ANY KIND ON BEHALF OF OPENLCR.COM, INC.**
- The Caller IQ service can only be activated after registering with openLCR at [www.openLCR.com](http://www.openLCR.com). More information regarding the openLCR service is available on the Internet at [www.openLCR.com](http://www.openLCR.com).

---

# Specifications

---

### Base unit

**Operating environment:**

5 °C – 40 °C (41 °F – 104 °F)

**Frequency:**

5.76 GHz – 5.84 GHz

**Dimensions:**

Approx. height 96 mm x width 210 mm x  
depth 157 mm ( $3^{25}/_{32}$ " x  $8^{1}/_{4}$ " x  $6^{3}/_{16}$ " )

**Mass (Weight):**

Approx. 405 g (0.89 lb.)

**Power consumption:**

Standby: Approx. 2.6 W

Maximum: Approx. 5.5 W

**Power supply:**

AC adaptor (120 V AC, 60 Hz)

---

### Handset

**Operating environment:**

5 °C – 40 °C (41 °F – 104 °F)

**Frequency:**

5.76 GHz – 5.84 GHz

**Dimensions:**

Approx. height 173 mm x width 48 mm x  
depth 33 mm ( $6^{13}/_{16}$ " x  $1^{7}/_{8}$ " x  $1^{5}/_{16}$ " )

**Mass (Weight):**

Approx. 168 g (0.37 lb.)

**Power supply:**

Ni-MH battery (3.6 V, 830 mAh)

**Security codes:**

1,000,000

**Note:**

- Design and specifications are subject to change without notice.

- The illustrations in these instructions may vary slightly from the actual product.

## Warranty

PANASONIC CONSUMER  
ELECTRONICS COMPANY, DIVISION  
OF PANASONIC CORPORATION OF  
NORTH AMERICA  
One Panasonic Way,  
Secaucus, New Jersey 07094

PANASONIC PUERTO RICO, INC.  
San Gabriel Industrial Park,  
Ave. 65 de Infantería, Km. 9.5,  
Carolina, Puerto Rico 00985

# Panasonic Telephone Products Limited Warranty

### Limited Warranty Coverage

If your product does not work properly because of a defect in materials or workmanship, Panasonic Consumer Electronics Company or Panasonic Puerto Rico, Inc. (collectively referred to as "the warrantor") will, for the length of the period indicated on the chart below, which starts with the date of original purchase ("Limited Warranty period"), at its option either (a) repair your product with new or refurbished parts, or (b) replace it with a new or a refurbished product. The decision to repair or replace will be made by the warrantor.

#### Parts

One (1) Year

#### Labor

One (1) Year

During the "Labor" Limited Warranty period there will be no charge for labor. During the "Parts" Limited Warranty period, there will be no charge for parts. You must mail-in your product during the Limited Warranty period. This Limited Warranty excludes both parts and labor for batteries, antennas, and cosmetic parts (cabinet). This Limited Warranty only applies to products purchased and serviced in the United States or Puerto Rico. This Limited Warranty is extended only to the original purchaser and only covers products purchased as new.

### Mail-In Service

For assistance in the continental U.S.A. in obtaining repairs please ship the product to:

#### Panasonic Services Company Customer Servicenter

4900 George McVay Drive Suite B Door #12 McAllen, TX 78503

For assistance in Puerto Rico call Panasonic Puerto Rico, Inc. (787)-750-4300 or fax (787)-768-2910.

For Limited Warranty service for headsets if a headset is included with this product please call Panasonic Call Center at 1-800-211-PANA (7262).

When shipping the unit carefully pack, include all accessories, and send it prepaid, adequately insured and preferably in the original carton. Include a letter detailing the complaint and provide a day time phone number where you can be reached.

**IF REPAIR IS NEEDED DURING THE LIMITED WARRANTY PERIOD THE PURCHASER WILL BE REQUIRED TO FURNISH A SALES RECEIPT/PROOF OF PURCHASE INDICATING DATE OF PURCHASE, AMOUNT PAID AND PLACE OF PURCHASE. CUSTOMER WILL BE CHARGED FOR THE REPAIR OF ANY UNIT RECEIVED WITHOUT SUCH PROOF OF PURCHASE.**

### Limited Warranty Limits And Exclusions

This Limited Warranty ONLY COVERS failures due to defects in materials or workmanship, and DOES NOT COVER normal wear and tear or cosmetic damage. The Limited Warranty ALSO DOES NOT COVER damages which occurred in shipment, or failures which are caused by products not supplied by the warrantor, or failures which result from accidents, misuse, abuse, neglect, mishandling, misapplication, alteration, faulty installation, set-up adjustments, misadjustment of consumer controls, improper maintenance, power line surge, lightning damage, modification, introduction of sand, humidity or liquids, commercial use such as hotel, office, restaurant, or other business or rental use of the product, or service by anyone other than a Factory Servicer or other Authorized Servicer, or damage that is attributable to acts of God.

**THERE ARE NO EXPRESS WARRANTIES EXCEPT AS LISTED UNDER "LIMITED WARRANTY COVERAGE". THE WARRANTOR IS NOT LIABLE FOR INCIDENTAL OR CONSEQUENTIAL DAMAGES RESULTING FROM THE USE OF THIS PRODUCT, OR ARISING OUT OF ANY BREACH OF THIS LIMITED WARRANTY.** (As examples, this excludes damages for lost time, lost calls or messages, cost of having someone remove or re-install an installed unit if applicable, travel to and from the servicer. The items listed are not exclusive, but are for illustration only.) **ALL EXPRESS AND IMPLIED WARRANTIES, INCLUDING THE WARRANTY OF MERCHANTABILITY, ARE LIMITED TO THE PERIOD OF THE LIMITED WARRANTY.**

Some states do not allow the exclusion or limitation of incidental or consequential damages, or limitations on how long an implied warranty lasts, so the exclusions may not apply to you.

This Limited Warranty gives you specific legal rights and you may also have other rights which vary from state to state. If a problem with this product develops during or after the Limited Warranty period, you may contact your dealer or Servicer. If the problem is not handled to your satisfaction, then write to the warrantor's Consumer Affairs Department at the addresses listed for the warrantor.

**PARTS AND SERVICE, WHICH ARE NOT COVERED BY THIS LIMITED WARRANTY, ARE YOUR RESPONSIBILITY.**



## Customer services

### **Customer Services Directory**

Obtain Product Information and Operating Assistance; locate your nearest Dealer or Servicenter; purchase Parts and Accessories; or make Customer Service and Literature requests by visiting our Web Site at:

**<http://www.panasonic.com/consumersupport>**

or, contact us via the web at:

**<http://www.panasonic.com/contactinfo>**

You may also contact us directly at: 1-800-211-PANA (7262),  
Monday-Friday 9 am-9 pm; Saturday-Sunday 10 am-7 pm, EST.

TTY users (hearing or speech impaired users) can call 1-877-833-8855.

### **Accessory Purchases**

Purchase Parts, Accessories and Instruction Books online for all Panasonic Products by visiting our Web Site at:

**<http://www.pasc.panasonic.com>**

or, send your request by E-mail to:

**[npcparts@us.panasonic.com](mailto:npcparts@us.panasonic.com)**

You may also contact us directly at:

1-800-332-5368 (Phone) 1-800-237-9080 (Fax Only)

(Monday - Friday 9 am to 8 pm, EST.)

Panasonic Services Company

20421 84th Avenue South, Kent, WA 98032

(We Accept Visa, MasterCard, Discover Card, American Express, and Personal Checks)

TTY users (hearing or speech impaired users) can call 1-866-605-1277.

### **Service in Puerto Rico**

Panasonic Puerto Rico, Inc.

San Gabriel Industrial Park, Ave. 65 de Infantería, Km. 9.5,

Carolina, Puerto Rico 00985

Phone (787)750-4300, Fax (787)768-2910

## Index

- A** Accessories: 5, 6
  - Accessory handset: 7
  - Answering calls
    - Base unit: 26
    - Handset: 25
  - Answering system: 60
  - Appearance: 55
  - Audio cable: 50
  - Auto talk: 25, 56
- B** Backlit display: 18
  - Backlit handset keypad: 18
  - Base unit location: 10
  - Battery
    - Charge: 13
    - Installation: 12
    - Performance: 13
    - Replacement: 14
    - Strength: 13
  - Belt clip: 73
  - Booster (Clarity booster): 22
- C** Caller ID edit: 55
  - Caller ID number auto edit: 36, 55
  - Caller ID service: 32
  - Caller list
    - Calling back: 35
    - Editing: 35
    - Erasing: 36
    - Storing: 36
    - Viewing: 35
  - Call screening: 61, 69
  - Call share: 22, 24
  - Call Waiting Caller ID: 32
  - Call waiting tone: 23, 24
  - Chain dial: 29
  - CID (Caller ID): 35
  - CONF (Conference): 40
  - Conference calls: 40
  - Connections
    - AC adaptor: 11
    - Telephone line cord: 11
  - Controls
    - Base unit: 15
    - Handset: 16
  - Copy phonebook: 30
  - Customer support: 53
  - Customized ring: 49
  - Customize ring: 50
- D** Date and time: 19
  - Deregistration: 58, 74
  - Dialing mode: 19
  - Display
    - Base unit: 17
    - Handset: 17
  - Display color: 55
  - Display language: 56
- E** Erasing all messages: 62, 64, 66
  - Erasing a message: 62, 64, 66
  - Erasing songs and pictures: 53
  - Error messages: 74
- F** FCC and other information: 83
  - FLASH button: 23, 24
  - Flash time: 57
  - Function menu
    - Direct commands: 46
    - Table: 43
- G** GIGARANGE USB Utility: 5, 27, 34, 49, 54
  - Greeting message: 60
- H** Handset locator: 37
  - Headset, optional: 73
  - Hold: 21, 24
- I** Intercom
  - Call: 37
  - Paging: 37
  - Interrupt tone
    - Base unit: 58
    - Handset: 56
- J** Joystick: 16
- K** Key tone: 56
- L** LCD contrast: 55, 56
  - Light-up ID: 34
  - Line mode: 57
  - Listening to messages
    - Base unit: 62
    - Handset: 63
    - Touch tone phone: 65
- M** Making calls
  - Base unit: 23
  - Handset: 20
- MEMO: 64
  - Memory capacity: 65
  - Memory status: 52

- Message alert: 69
- Microphone
  - Base unit: 23, 60
  - Handset: 20
- Mute: 21, 24
- N** Noise: 10
- P** Pause: 22, 31
- Phonebook
  - Adding: 27
  - Calling: 28
  - Copying: 30
  - Editing: 29
  - Erasing: 29
  - Names: 27
  - Option: 33
- Picture ID: 34
- Power failure: 11, 82
- Privacy feature: 22
- Pulse service: 23, 25
- R** Recording time: 69
- Redial: 20, 24
- Redial list: 21
- Registration: 59
- Remote code: 67
- Remote operation: 65
- Ring color: 51
- Ring count: 68
- Ringer ID: 33
- Ringer off
  - Base unit: 26, 57
  - Handset: 25, 49
- Ringer tone
  - Base unit: 26, 58
  - Handset: 49
- Ringer volume
  - Base unit: 26, 57
  - Handset: 49
- Room monitor: 41
- Rotary service, tone dialing: 23, 25
- S** Safety instructions: 8
- Soft keys: 18
- Specifications: 86
- Speed dialer: 31
- SP-phone
  - Base unit: 23
  - Handset: 20
- T** Talking Caller ID
  - Base unit: 32, 58
  - Handset: 32, 55
- Time adjustment: 59
- Toll saver: 68
- Troubleshooting
  - Answering system: 80
  - Battery recharge: 81
  - Caller ID: 79
  - General use: 76
  - Making/answering calls, Intercom: 77
  - Phonebook: 78
  - Power failure: 82
  - Programmable settings: 76
  - TTY: 5, 6, 89
- U** USB cable: 34, 49, 54
- V** VE (voice enhancer): 21
- Voice enhancer: 21, 52
- Voice guidance: 63, 66
- Voice memo: 64
- Voice paging: 38
- Volume control
  - Base unit: 24, 57, 62
  - Handset receiver: 20
  - Handset speaker: 20
- W** Wall mounting: 70
- Wallpaper: 54
- Warranty: 87

## ***If you need assistance with setup or operation;***

- 1** Visit our website: <http://www.panasonic.com/consumersupport>
- 2** Contact us via the web at: <http://www.panasonic.com/contactinfo>
- 3** Call us at: 1-800-211-PANA (7262)  
TTY users (hearing or speech impaired users) can call 1-877-833-8855.

### **When you ship the product;**

- Carefully pack your unit, preferably in the original carton.
- Attach a letter, detailing the symptom, to the outside of the carton.
- Send the unit to Panasonic Services Company Customer Servicer, prepaid and adequately insured.
- Do not send your unit to Panasonic Consumer Electronics Company listed below or to executive or regional sales offices. These locations do not repair consumer products.

- |   |
|---|
| <ul style="list-style-type: none"><li>• This cordless telephone is designed for use in the United States of America. Sale or use of this product in other countries may violate local laws.</li><li>• Ce téléphone sans fil est conçu pour être utilisé aux États-Unis d'Amérique. La vente ou l'emploi de cet appareil dans certains autres pays peut constituer une infraction à la législation locale.</li><li>• Este teléfono inalámbrico fue elaborado para uso en los Estados Unidos de América. La venta o el empleo de este producto en ciertos países puede constituir violación de la legislación local.</li><li>• このコードレス電話機は、日本国外での使用を目的として設計されており、日本国内での使用は法律違反となります。従って、当社では日本国内においては原則として修理などのサービスは致しかねます。</li></ul> |
|---|

### **Copyright:**

This material is copyrighted by Panasonic Communications Co., Ltd., and may be reproduced for internal use only. All other reproduction, in whole or in part, is prohibited without the written consent of Panasonic Communications Co., Ltd.  
© 2005 Panasonic Communications Co., Ltd. All Rights Reserved.

**Panasonic Consumer Electronics Company,  
Division of Panasonic Corporation of North America**  
One Panasonic Way, Secaucus, New Jersey 07094

**Panasonic Puerto Rico, Inc.**  
San Gabriel Industrial Park, Ave. 65 de Infantería, Km. 9.5,  
Carolina, Puerto Rico 00985